

Algorithms for Scientific Computing

Wavelets

Michael Bader
Technical University of Munich

Summer 2018



TUM Uhrenturm

Part I

Haar Wavelets as an Hierarchical Basis

Remember the 1D Hierarchical Basis

- “mother of all hat functions”: $\phi(x) := \max\{1 - |x|, 0\}$
- hat functions on level $l \in \mathbb{N}$ with mesh width $h_l = 2^{-l}$ at grid points $x_{l,i} = i \cdot h_l$:

$$\phi_{l,i}(x) := \phi\left(\frac{x - x_{l,i}}{h_l}\right)$$

- hierarchical basis functions on level l :

$$\phi_{l,i}(x) \quad \text{for all } i \in \mathcal{I}_l := \{i : 1 \leq i < 2^l, i \text{ odd}\}$$

- resulting hierarchical basis

$$\Psi_n := \bigcup_{l=1}^n \{\phi_{l,i} : i \in \mathcal{I}_l\}.$$

- with corresponding function spaces:

$$W_l := \text{span} \{\phi_{l,i} : i \in \mathcal{I}_l\} \quad \text{and} \quad V_n = \bigoplus_{l=1}^n W_l$$

Hierarchical vs. Nodal Basis

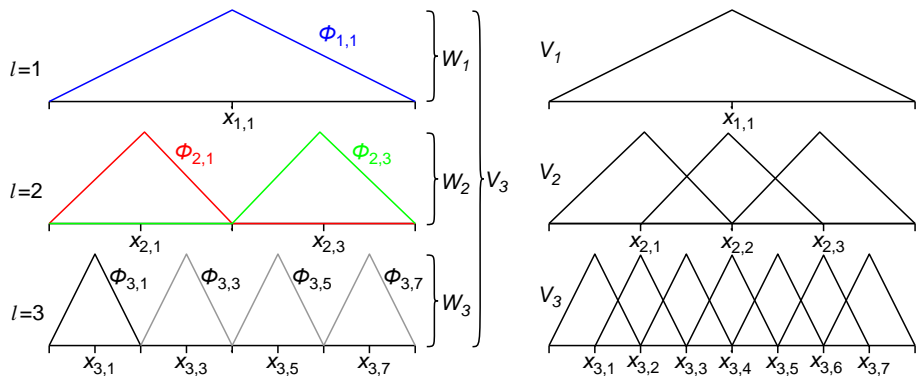

→ for piecewise *linear* (basis) functions

Now: how to build a piecewise constant basis?

Piecewise Constant Basis – Attempt # 1

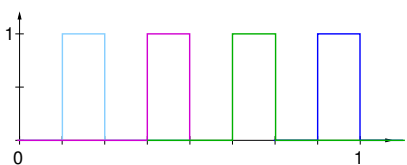
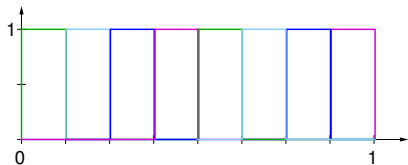
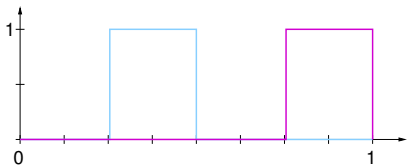
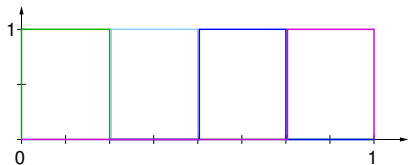
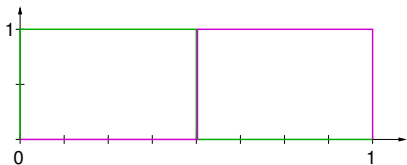
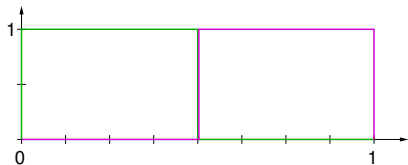

Piecewise Constant Basis – Attempt # 1 (cont.)

Discussion:

- obviously qualifies as a “hierarchical basis” w.r.t. hierarchical levels and mesh widths
- built from a “mother of all step functions”, e.g.:

$$\phi(x) := \begin{cases} 1 & \text{if } 0 < x < 1 \\ 0 & \text{otherwise} \end{cases}$$

- hierarchical basis functions on level l : $\phi_{l,i}(x) := \phi\left(\frac{x - x_{l,i}}{h_l}\right)$
- nodal basis on level l : $V_l = \text{span}\{\phi_{l,i}(x) : i = 0, \dots, 2^l - 1\}$
- hierarchical surplus: $W_l = \text{span}\{\phi_{l,i}(x) : 1 \leq i < 2^l, i \text{ odd}\}$
- would hierarchical surpluses be small in such a setting?
- are functions represented well by coarse-level basis functions?

Attempt # 2: “Hierarchical Haar Basis”

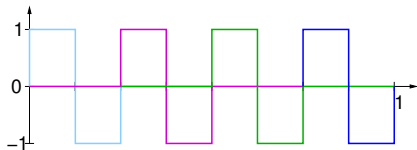
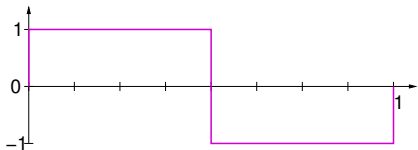
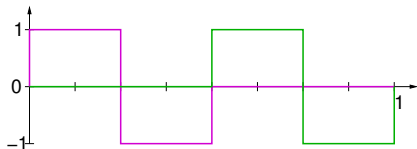
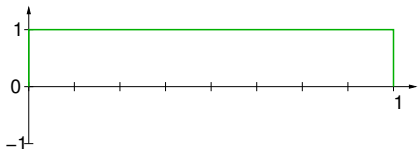

- for each *interval*, we obtain a contribution from each *level*
- course-level representations will consist of *average values*
- each “surplus” level add corrections to averages

Hierarchical Haar Basis

- again a hierarchical basis with “mother Haar function”:

$$\psi(x) := \begin{cases} 1 & \text{if } 0 < x < 1 \\ -1 & \text{if } 1 < x < 2 \\ 0 & \text{otherwise} \end{cases}$$

- hierarchical Haar basis functions on level l :

$$\psi_{l,i}(x) := \psi\left(\frac{x - x_{l,i}}{h_l}\right) \quad \text{for all } i \in \mathcal{I}_l := \{i : 0 \leq i < 2^l, i \text{ even}\}$$

- hierarchical surplus space for each level:

$$W_l := \text{span} \{\psi_{l,i} : i \in \mathcal{I}_l\}$$

- space of piecewise constant functions $V_n = \bigoplus_{l=0}^n W_l$
 → includes a step function on interval $(0, 1)$ for $l = 0$

Hierarchical Haar Basis – Coefficients

- consider a piecewise constant function $\in V_1$:

$$s(x) := a\phi_{1,0}(x) + b\phi_{1,1}(x) \begin{cases} a & \text{if } 0 < x < \frac{1}{2} \\ b & \text{if } \frac{1}{2} < x < 1 \\ 0 & \text{otherwise} \end{cases}$$

- condition in interval $0 < x < \frac{1}{2}$:

$$v_{0,0} \underbrace{\psi_{0,0}(x)}_{=\phi_{0,0}(x)} + v_{1,0}\psi_{1,0}(x) = v_{0,0} + v_{1,0} = a$$

- condition in interval $\frac{1}{2} < x < 1$:

$$v_{0,0}\psi_{0,0}(x) + v_{1,0}\psi_{1,0}(x) = v_{0,0} - v_{1,0} = b$$

- solve linear system of equations:

$$v_{0,0} = \frac{1}{2}(a + b) \quad v_{1,0} = \frac{1}{2}(a - b)$$

Hierarchical Haar Basis – Transformation

- represent a piecewise constant function $s(x) \in V_l$:

$$s(x) = \sum_{i=0}^{2^l-1} c_{l,i} \phi_{l,i}(x)$$

- write as coarse function plus hierarchical surplus:

$$s(x) = \underbrace{\sum_i c_{l,i} \phi_{l,i}(x)}_{\in V_l} = \underbrace{\sum_i c_{l-1,i} \phi_{l-1,i}(x)}_{\in V_{l-1}} + \underbrace{\sum_{i \in \mathcal{I}_l} d_{l,i} \psi_{l,i}(x)}_{\in W_l}$$

- examine intervals $x_{l,2i} < x < x_{l,2i+1}$ and $x_{l,2i+1} < x < x_{l,2i+2}$:

$$c_{l-1,i} + d_{l,2i} = c_{l,2i} \quad \text{and} \quad c_{l-1,i} - d_{l,2i} = c_{l,2i+1}$$

- leads to formula for $c_{l-1,i}$ and $d_{l,2i}$ (note the even index $2i$):

$$c_{l-1,i} = \frac{1}{2}(c_{l,2i} + c_{l,2i+1}) \quad d_{l,2i} = \frac{1}{2}(c_{l,2i} - c_{l,2i+1})$$

Part II

Haar Wavelets as Wavelets

Change of Notation – Scaling Function

- define **scaling function**:

$$\phi(x) := \begin{cases} 1 & \text{if } 0 < x < 1 \\ 0 & \text{otherwise} \end{cases}$$

- nodal basis functions on level l :

$$\phi_{l,k}(x) := 2^{l/2} \phi\left(\frac{x - x_{l,k}}{h_l}\right) = 2^{l/2} \phi\left(\frac{x - k \cdot 2^{-l}}{2^{-l}}\right) = 2^{l/2} \phi(2^l x - k)$$

(remember: $x_{l,k} = k \cdot 2^{-l}$ and $h_l = 2^{-l}$)

- scaling with $2^{l/2}$ to be discussed ...
- resulting nodal basis on level l :

$$V_l = \text{span}\{\phi_{l,k}(x) : k = 0, \dots, 2^l - 1\}$$

Change of Notation – Wavelet Functions

- define **mother Haar wavelet**:

$$\psi(x) := \begin{cases} 1 & \text{if } 0 < x < \frac{1}{2} \\ -1 & \text{if } \frac{1}{2} < x < 1 \\ 0 & \text{otherwise} \end{cases}$$

- Haar wavelet functions** on level l :

$$\psi_{l,k}(x) := 2^{l/2} \psi(2^l x - k) = 2^{l/2} \psi\left(\frac{x - 2^{-l}k}{2^{-l}}\right) = 2^{l/2} \psi\left(\frac{x - x_{l,k}}{h_l}\right)$$

for $k = 0, \dots, 2^l - 1$, (but no “stride two”)

- Important changes:
 - shifted numbering of levels: $\psi(x)$ defined on $[0, 1]$
 - thus: supports of $\psi_{l,k}(x)$ and $\psi_{l,k+1}(x)$ no longer overlap
 - index $k = 0, \dots, 2^l - 1$ used with “stride 1”

Change of Notation – Wavelet Functions (cont.)

- define **mother Haar wavelet**:

$$\psi(x) := \begin{cases} 1 & \text{if } 0 < x < \frac{1}{2} \\ -1 & \text{if } \frac{1}{2} < x < 1 \\ 0 & \text{otherwise} \end{cases}$$

- Haar wavelet functions** on level l :

$$\psi_{l,k}(x) := 2^{l/2} \psi(2^l x - k) \quad \text{for } k = 0, \dots, 2^l - 1.$$

- wavelet space for each level:

$$W_l := \text{span} \left\{ \psi_{l,k} : k = 0, \dots, 2^l - 1 \right\}$$

- definition of function spaces: $V_{l+1} = V_l \oplus W_l$

Haar Wavelet Functions

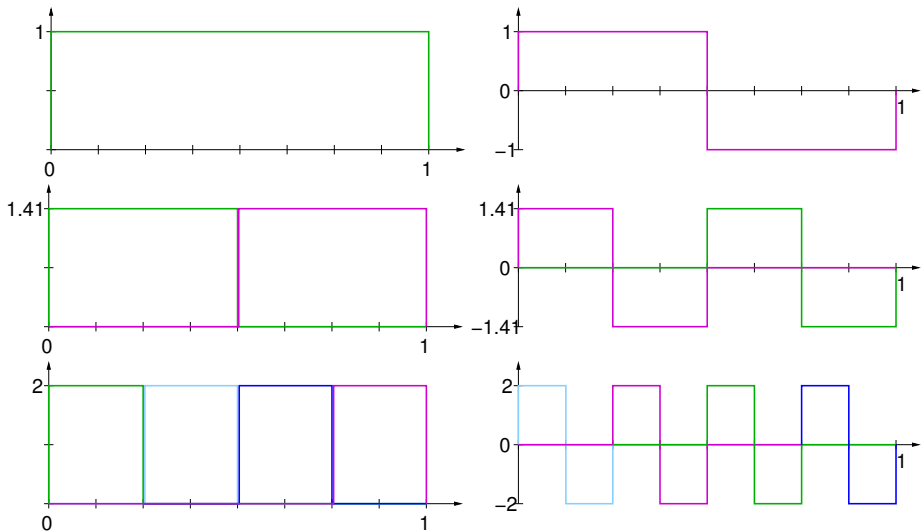

Haar Wavelets – Transformation

- represent a piecewise constant function $s(x) \in V_l$:

$$s(x) = \sum_{k=0}^{2^l-1} c_{l,k} \phi_{l,k}(x)$$

- write as coarse function plus hierarchical surplus:

$$s(x) = \underbrace{\sum_k c_{l,k} \phi_{l,k}(x)}_{\in V_l} = \underbrace{\sum_k c_{l-1,k} \phi_{l-1,k}(x)}_{\in V_{l-1}} + \underbrace{\sum_k d_{l-1,k} \psi_{l-1,k}(x)}_{\in W_{l-1}}$$

- transform $c_{l,2k}$ to $c_{l-1,k}$ and $d_{l-1,k}$:

$$c_{l-1,k} = \frac{1}{\sqrt{2}}(c_{l,2k} + c_{l,2k+1}) \quad d_{l-1,k} = \frac{1}{\sqrt{2}}(c_{l,2k} - c_{l,2k+1})$$

- backward transform $c_{l-1,k}$ and $d_{l-1,k}$ to $c_{l,2k}$ and $c_{l,2k+1}$:

$$c_{l,2k} = \frac{1}{\sqrt{2}}(c_{l-1,k} + d_{l-1,k}) \quad c_{l,2k+1} = \frac{1}{\sqrt{2}}(c_{l-1,k} - d_{l-1,k})$$

Haar Wavelets – Transformation (2)

- scheme for wavelet decomposition:

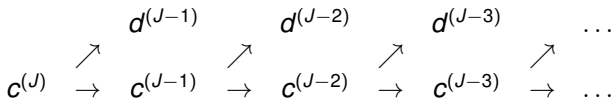

- scheme for assembly:

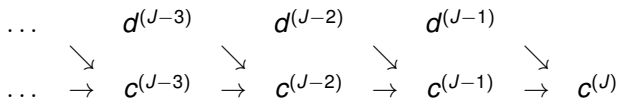

- Note: computational effort for transformations is only $\mathcal{O}(N)$

Haar Wavelets – Transformation (3)

Scheme for data structures:

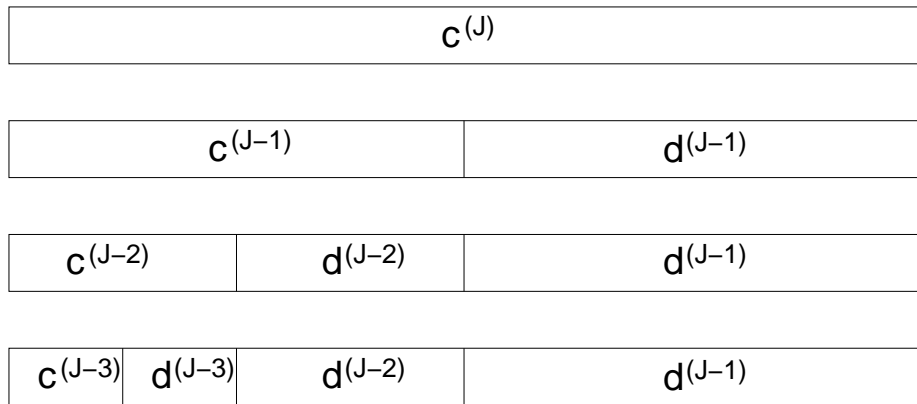

Haar Wavelets – Orthogonality

- Haar wavelets are **orthogonal** functions:

$$\int \psi_{l,i}(x) \psi_{m,j}(x) dx := \begin{cases} 1 & \text{if } l = m \text{ and } i = j \\ 0 & \text{otherwise} \end{cases}$$

- two different wavelet functions $\psi_{l,i} \neq \psi_{l,j}$ on the same level l

$$\int \psi_{l,i}(x) \psi_{l,j}(x) dx = 0 \quad (\text{no overlap of functions!})$$

- two wavelet functions $\psi_{l,i} \neq \psi_{m,j}$ on different levels $l < m$

$$\int \psi_{l,i}(x) \psi_{m,j}(x) dx = \psi_{l,i}(x_{m,j}^+) \int \psi_{m,j}(x) dx = 0$$

- scalar product of a wavelet functions $\psi_{l,i}$ with itself

$$\int (\psi_{l,i}(x))^2 dx = \int_{x_{l,i}}^{x_{l,i}+2^{-l}} (2^{l/2})^2 dx = 1$$

Haar Wavelets – Summary and Next Steps

Haar wavelets:

- hierarchical basis of **piecewise constant** and ...
- ... **orthogonal** basis functions
- $\mathcal{O}(N)$ effort for hierarchical transformation (compare tutorial)

Next steps:

- applications in signal and image processing
- extension to 2D (and higher dimensions)
- is there a piecewise linear/polynomial/higher-order orthogonal(!) wavelet basis?

Part III

Wavelets in Signal and Image Processing

Scaling Functions and Wavelet Functions in 2D

Use tensor product, as for hierarchical basis:

- 2D scaling functions on levels l_1, l_2 :

$$\phi_{\vec{l}, \vec{k}}(x_1, x_2) := \phi_{l_1, l_2, k_1, k_2}(x_1, x_2) := \phi_{l_1, k_1}(x_1) \cdot \phi_{l_2, k_2}(x_2)$$

- 2D wavelet functions on levels l_1, l_2 :

$$\psi_{\vec{l}, \vec{k}}(x_1, x_2) := \psi_{l_1, l_2, k_1, k_2}(x_1, x_2) := \psi_{l_1, k_1}(x_1) \cdot \psi_{l_2, k_2}(x_2)$$

- thus straightforward extension to 3D and higher dimensions
- 2D transform equivalent to sequence of 1D transforms
(same as for Fourier Transforms and also for Hierarchical Basis)

2D Wavelets – A Single Transformation Step

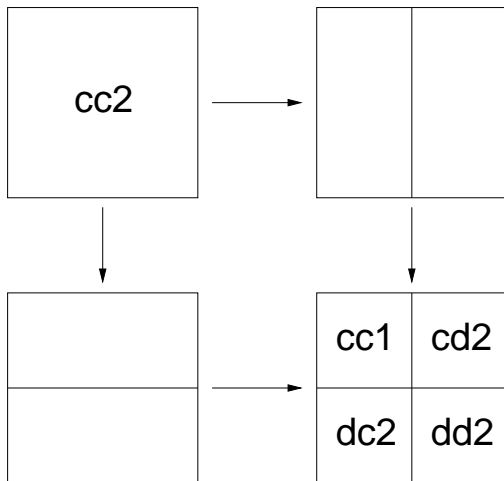

2D Wavelets – Storage Scheme

cc1	cd1	cd2	cd3
dc1	dd1		
dc2		dd2	
dc3		dd3	

Wavelet-Based Compression of Image Data

Typical steps for image compression:

1. Conversion of colour model
(separation of brightness and colour information)
2. **2D discrete Wavelet transform**
3. **Quantisation of the coefficients** (→ reduce information)
4. efficient encoding
(loss-less compression of the quantised coefficients)

In practice:

- different algorithms: EZF, SPIHT, ...
- similar to JPEG, but often much better quality
- see, e.g., Walker: “Wavelet-based Image Compression”
for full details

Example: 3D Image Compression

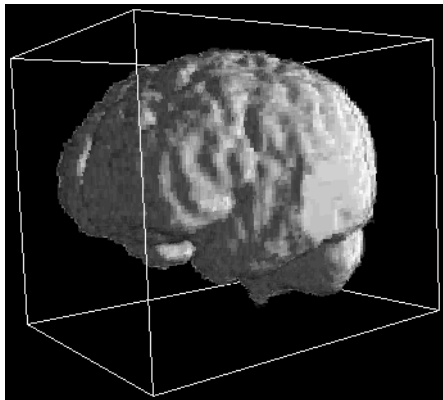
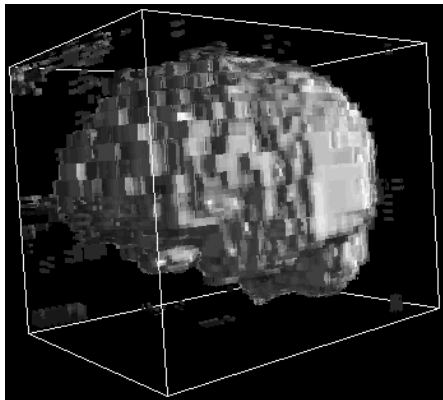

(wavelet-based compression of raster data, A. Dehmel)

Example: 3D Image Compression (2)

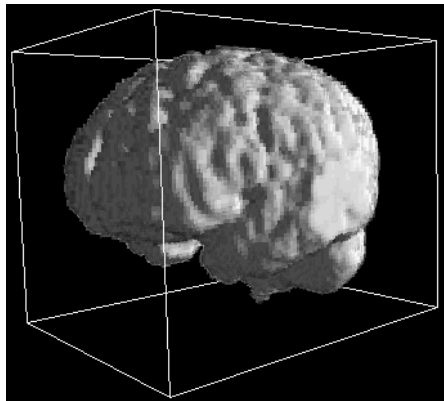
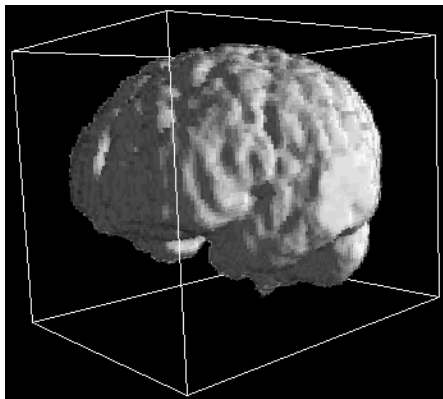

(wavelet-based compression of raster data, A. Dehmel)

From Fourier Transform to Wavelets

(Discrete) Fourier Transform:

$$f(x) \sim \sum c_k e^{ikx} \quad \text{or} \quad f_n = \sum F_k e^{i\pi kn/N}$$

- f contains only spatial information
- c_k, F_k contain only frequency information
- no relation between frequency and location

Windowed Fourier Transform:

$$f(x) = \frac{1}{2\pi} \int \int F(u, k) g(x - u) e^{ikx} dk du, \quad F(u, k) = \int f(x) g(x - u) e^{-ikx} dx$$

- $F(u, k)$: frequency k at location u
- $g(\xi)$ a window function
 - narrow windows do not allow to locate coarse frequencies
 - but wide windows decrease accuracy in location

From Fourier Transform to Wavelets (2)

Continuous Wavelet Transform:

$$W(a, b) = \int f(t)\psi_a^b(t) dt \quad \text{and} \quad f(x) = \frac{1}{C_\psi} \int \int W(a, b) \frac{\psi_a^b(x)}{a^2} da db$$

- continuous in a and b
- $\psi_a^b(t) = |a|^{-1/2} \psi\left(\frac{t-b}{a}\right)$ with “mother wavelet” ψ
- infinitely many (redundant) coefficients \rightarrow computationally not feasible

Multiresolution Analysis/Discrete Wavelet Transform:

- restrict (a, b) to discrete values $(a, b) := \left(\frac{1}{2^j}, \frac{k}{2^j}\right)$
- thus discrete wavelet functions:

$$\psi_{j,k} = \psi_k^{2^{-j}} = 2^{j/2} \psi(2^j t - k)$$

- combines frequency and location: higher spatial resolution for higher frequencies

Part IV

More Complicated Wavelets

Reference/more details \rightsquigarrow Aboufadel & Schlicker: Discovering Wavelets

Mother and Father Wavelets – General Situation

- **mother wavelet** $\psi(x)$
- **father wavelet** $\phi(x)$, also called **scaling function**
- basis built from scaling functions on each level l :

$$\phi_{l,k}(x) := 2^{l/2} \phi(2^l x - k) \quad V_l := \text{span} \{ \phi_{l,k}(x) \}$$

- surplus basis built from wavelet functions on each level l :

$$\psi_{l,k}(x) := 2^{l/2} \psi(2^l x - k) \quad W_l := \text{span} \{ \psi_{l,k}(x) \}$$

- definition of function spaces: $V_{l+1} = V_l \oplus W_l$
- wavelet basis functions are **orthonormal**:

$$\langle \psi_{l,k}(x), \psi_{m,j}(x) \rangle = \int \psi_{l,k}(x) \psi_{m,j}(x) dx = \begin{cases} 1 & \text{if } l = m \text{ and } k = j \\ 0 & \text{otherwise} \end{cases}$$

- also: scaling basis functions are orthonormal on each level

Scaling and Wavelet Functions

- note: $\phi_{l-1,k} \in V_l \supset V_{l-1}$, and also $\psi_{l-1,k} \in V_l = V_{l-1} \oplus W_{l-1}$
- hence, all $\phi_{l-1,k}$ and $\psi_{l-1,k}$ can be uniquely represented via the basis functions of V_l , i.e., the $\phi_{l,k}$:

$$\phi_{l-1,0}(x) = \sum_i p_i \phi_{l,i}(x) = 2^{l/2} \sum_i p_i \phi(2^l x - i)$$

$$\psi_{l-1,0}(x) = \sum_i q_i \phi_{l,i}(x) = 2^{l/2} \sum_i q_i \phi(2^l x - i)$$

- for efficiency: p_i and q_i should be non-zero for only a few i
- for Haar wavelets:

$$p_0 = \frac{1}{\sqrt{2}}, \quad p_1 = \frac{1}{\sqrt{2}}, \quad \text{all other } p_i = 0$$

$$q_0 = \frac{1}{\sqrt{2}}, \quad q_1 = -\frac{1}{\sqrt{2}}, \quad \text{all other } q_i = 0$$

Scaling and Wavelet Functions (2)

- do for all scaling functions $\phi_{l-1,k}$:

$$\begin{aligned}\phi_{l-1,k}(x) &= 2^{l/2} \sum_i p_i \phi(2^l x - 2k - i) \\ &\stackrel{2k+i \rightarrow i}{=} 2^{l/2} \sum_i p_{i-2k} \phi(2^l x - i) = \sum_i p_{i-2k} \phi_{l,i}(x)\end{aligned}$$

Note: $\phi_{l,k}(x) = 2^{l/2} \phi(2^l x - k) = 2^{l/2} \phi(2^l x - 2^l \frac{k}{2^l}) = 2^{l/2} \phi(2^l (x - \frac{k}{2^l})) = \phi_{l,0}(x - \frac{k}{2^l})$
and thus: $\phi_{l-1,k}(x) = \phi_{l-1,0}(x - \frac{k}{2^{l-1}}) = 2^{l/2} \sum_i q_i \phi(2^l (x - \frac{k}{2^{l-1}}) - i) = \dots$

- and similar for wavelet functions: $\psi_{l-1,k}(x) = \sum_i q_{i-2k} \phi_{l,i}(x)$
- for Haar wavelets:
 p_{i-2k} and q_{i-2k} are non-zero only for $i = 2k$ and $i = 2k + 1$:

$$\phi_{l-1,k}(x) = \frac{1}{\sqrt{2}} \phi_{l,2k}(x) + \frac{1}{\sqrt{2}} \phi_{l,2k+1}(x)$$

$$\psi_{l-1,k}(x) = \frac{1}{\sqrt{2}} \phi_{l,2k}(x) - \frac{1}{\sqrt{2}} \phi_{l,2k+1}(x)$$

Wavelet Transformations and Filtering

- consider a signal function represented on (fine) level $l + 1$:

$$f_{l+1}(x) = \sum_i c_i^{(l+1)} \phi_{l+1,i}(x)$$

- and a decomposition $f_{l+1} = f_l + g_l$, where $f_l \in V_l$ and $g_l \in W_l$:

$$\begin{aligned} f_{l+1}(x) &= \sum_i c_i^{(l+1)} \phi_{l+1,i}(x) = \sum_j c_j^{(l)} \phi_{l,j}(x) + \sum_j d_j^{(l)} \psi_{l,j}(x) \\ &= \sum_j \left(c_j^{(l)} \sum_i p_{i-2j} \phi_{l+1,i}(x) \right) + \sum_j \left(d_j^{(l)} \sum_i q_{i-2j} \phi_{l+1,i}(x) \right) \\ &= \sum_i \phi_{l+1,i}(x) \sum_j \left(p_{i-2j} c_j^{(l)} + q_{i-2j} d_j^{(l)} \right) \end{aligned}$$

- two different representations of $f_{l+1}(x)$, but $\{\phi_{l+1,k}(x)\}$ a basis:

$$\Rightarrow c_i^{(l+1)} = \sum_j \left(p_{i-2j} c_j^{(l)} + q_{i-2j} d_j^{(l)} \right)$$

Wavelet Transformations and Filtering (2)

- p_i and q_i determine transformation of coefficients:

$$c_i^{(l+1)} = \sum_j \left(p_{i-2j} c_j^{(l)} + q_{i-2j} d_j^{(l)} \right)$$

- solves assembly:
for given f_l and g_l (i.e., given coefficients $c_j^{(l)}$ and $d_j^{(l)}$),
find coefficients $c_i^{(l+1)}$ for f_{l+1}
- for Haar wavelets:

$$\begin{aligned} \text{even } i: \quad c_i^{(l+1)} &= \frac{1}{\sqrt{2}} c_{i/2}^{(l)} + \frac{1}{\sqrt{2}} d_{i/2}^{(l)} \\ \text{odd } i: \quad c_i^{(l+1)} &= \frac{1}{\sqrt{2}} c_{(i-1)/2}^{(l)} - \frac{1}{\sqrt{2}} d_{(i-1)/2}^{(l)} \end{aligned}$$

Wavelet Transformations and Filtering (3)

- now: fine-level representation given as

$$f_{l+1}(x) = \sum_i c_i^{(l+1)} \phi_{l+1,i}(x)$$

- wanted: decomposition $f_{l+1} = f_l + g_l$ with

$$f_l(x) + g_l(x) = \sum_j c_j^{(l)} \phi_{l,j}(x) + \sum_j d_j^{(l)} \psi_{l,j}(x)$$

- use that $\{\phi_{l,k}(x)\}$ and $\{\psi_{l,k}(x)\}$ are **orthonormal** basis for V_l and W_l , and $V_l \perp W_l$:

$$\begin{aligned} \Rightarrow c_j^{(l)} &= \langle f_{l+1}(x), \phi_{l,j}(x) \rangle = \left\langle \sum_i c_i^{(l+1)} \phi_{l+1,i}(x), \phi_{l,j}(x) \right\rangle \\ &= \sum_i c_i^{(l+1)} \langle \phi_{l+1,i}(x), \phi_{l,j}(x) \rangle \\ &= \dots \end{aligned}$$

Wavelet Transformations and Filtering (4)

- continued:

$$\begin{aligned}
 c_j^{(l)} &= \langle f_{l+1}(x), \phi_{l,j}(x) \rangle = \dots = \sum_i c_i^{(l+1)} \langle \phi_{l+1,i}(x), \phi_{l,j}(x) \rangle \\
 &= \sum_i c_i^{(l+1)} \left\langle \phi_{l+1,i}(x), \sum_k p_{k-2j} \phi_{l+1,k}(x) \right\rangle \\
 &= \sum_i c_i^{(l+1)} \sum_k p_{k-2j} \langle \phi_{l+1,i}(x), \phi_{l+1,k}(x) \rangle = \sum_i c_i^{(l+1)} p_{i-2j}
 \end{aligned}$$

- similar computation for $d_j^{(l)}$, and therefore:

$$c_j^{(l)} = \sum_i p_{i-2j} c_i^{(l+1)} \quad d_j^{(l)} = \sum_i q_{i-2j} c_i^{(l+1)}$$

- again, for Haar wavelets:

$$c_j^{(l)} = \frac{1}{\sqrt{2}} c_{2j}^{(l+1)} + \frac{1}{\sqrt{2}} c_{2j+1}^{(l+1)} \quad d_j^{(l)} = \frac{1}{\sqrt{2}} c_{2j}^{(l+1)} - \frac{1}{\sqrt{2}} c_{2j+1}^{(l+1)}$$

Wavelet Transformations and Filtering – Summary

Wanted: decomposition $f_{l+1} = f_l + g_l$ with

- coarser representation $f_l(x) = \sum c_j^{(l)} \phi_{l,j}(x)$ with

$$c_j^{(l)} = \sum_i p_{i-2j} c_i^{(l+1)}$$

corresponds to a **low-pass filter** (averaging)

- oscillatory surplus $g_l(x) = \sum d_j^{(l)} \psi_{l,j}(x)$ with

$$d_j^{(l)} = \sum_i q_{i-2j} c_i^{(l+1)}$$

corresponds to a **high-pass filter** (difference computation)

- and reconstruction: $c_i^{(l+1)} = \sum_j \left(p_{i-2j} c_j^{(l)} + q_{i-2j} d_j^{(l)} \right)$

How to Determine the Filtering Coefficients?

- we need coefficients for low-pass and high-pass filter:

$$c_j^{(l)} = \sum_i p_{i-2j} c_i^{(l+1)} \quad d_j^{(l)} = \sum_i q_{i-2j} c_i^{(l+1)}$$

- reconstruction then: $c_i^{(l+1)} = \sum_j (p_{i-2j} c_j^{(l)} + q_{i-2j} d_j^{(l)})$
- requires **scaling equation** for scaling and wavelet functions:

$$\phi_{l-1,k}(x) = \sum_i p_{i-2k} \phi_{l,i}(x) \quad \psi_{l-1,k}(x) = \sum_i q_{i-2k} \phi_{l,i}(x)$$

- requires **orthogonal** scaling and wavelet functions:
 - $\phi_{l,k} \perp \phi_{l,j}$ and $\psi_{l,k} \perp \psi_{l,j}$ for $k \neq j$
 - $\psi_{l,k} \perp \phi_{m,j}$ if $m \leq l$ and arbitrary k, j (i.e., $W_l \perp V_m$)

How to Determine the Wavelet Functions? (2)

- **scaling equation** for mother and father wavelet:

$$\phi(x) = \sqrt{2} \sum_k p_k \phi(2x - k) \quad \psi(x) = \sqrt{2} \sum_k q_k \phi(2x - k)$$

also called **dilation equation**

- for Haar wavelet:

$$\phi(x) = \phi(2x) + \phi(2x - 1) \quad \psi(x) = \phi(2x) - \phi(2x - 1)$$

- for more complicated wavelets:
 - more than 2 non-zeros p_k (and q_k)
 - p_k and q_k determined to satisfy orthogonality
 - often no analytical expression for $\phi(x)$ and $\psi(x)$ available
 - obtain $\phi(x)$ and $\psi(x)$ as solutions of the scaling equation
→ see worksheet “cranking the machine”

Towards More Complicated Wavelets

“Wish List:”

- orthonormal basis of scaling functions on each level:

$$\langle \phi_{l,k}(x), \phi_{l,j}(x) \rangle = \begin{cases} 1 & \text{if } k = j \\ 0 & \text{otherwise} \end{cases}$$

- scaling/wavelet functions obey top scaling equation:

$$\phi_{l-1,k}(x) = \sum_i p_{i-2k} \phi_{l,i}(x) \quad \psi_{l-1,k}(x) = \sum_i q_{i-2k} \phi_{l,i}(x)$$

- scaling/wavelet functions have **compact support**
 $\rightsquigarrow p_i \neq 0$ only for few i (same for q_i)
- as additional criteria: “vanishing moments” of wavelet functions

$$\int \psi(t) dt = 0 \quad \int t\psi(t) dt = 0 \quad \text{etc.}$$

Towards More Complicated Wavelets (2)

orthonormal basis of scaling functions:

- on each level:

$$\langle \phi_{l,k}(x), \phi_{l,j}(x) \rangle = \begin{cases} 1 & \text{if and } k = j \\ 0 & \text{otherwise} \end{cases}$$

- combine with scaling equation and compact support:

$$\phi_{l-1,k}(x) = \sum_i p_{i-2k} \phi_{l,i}(x) \quad \text{where } p_i \neq 0 \text{ only for few } i$$

and obtain:

$$\begin{aligned} \langle \phi_{l-1,k}(x), \phi_{l-1,m}(x) \rangle &= \left\langle \sum_i p_{i-2k} \phi_{l,i}(x), \sum_j p_{j-2m} \phi_{l,j}(x) \right\rangle \\ &= \sum_i p_{i-2k} \sum_j p_{j-2m} \langle \phi_{l,i}(x), \phi_{l,j}(x) \rangle = \sum_i p_{i-2k} p_{i-2m} \end{aligned}$$

- in particular (for $k = m$): $\sum_i (p_{i-2k})^2 = \sum_i p_i^2 = 1$

Towards More Complicated Wavelets (3)

- in addition – for $k = 0$ and arbitrary $m \neq 0$:

$$\langle \phi_{l-1,0}(x), \phi_{l-1,m}(x) \rangle = \sum_i p_i p_{i-2m} = 0$$

- similar argument: scaling and wavelet functions are orthogonal!

$$\begin{aligned} \langle \phi_{l-1,0}(x), \psi_{l-1,0}(x) \rangle &= \left\langle \sum_i p_i \phi_{l,i}(x), \sum_j q_j \phi_{l,j}(x) \right\rangle \\ &= \sum_i p_i \sum_j q_j \langle \phi_{l,i}(x), \phi_{l,j}(x) \rangle = \sum_i p_i q_i \stackrel{!}{=} 0 \end{aligned}$$

- and wavelet functions of one level are orthogonal:

$$\langle \psi_{l,k}(x), \psi_{l,m}(x) \rangle = 0 \quad \rightsquigarrow \sum_i q_i q_{i-2(k-m)} = \begin{cases} 0 & \text{if } k \neq m \\ 1 & \text{if } k = m \end{cases}$$

- to satisfy these requirements: $q_k = (-1)^k p_{1-k}$

Daubechies Wavelets (D4)

- setting: $\phi(x) = 0$ outside of interval $[0, 3]$
 → non-zero coefficients are $p_0, p_1, p_2,$ and p_3
- orthogonality requires $\sum p_i^2 = 1$ and $\sum p_i p_{i-2m} = 0$:

$$p_0^2 + p_1^2 + p_2^2 + p_3^2 = 1 \quad \text{and} \quad p_0 p_2 + p_1 p_3 = 0$$

- plus vanishing moments $\int \psi(t) dt = 0$ and $\int t\psi(t) dt = 0$
 together with $q_k = (-1)^k p_{1-k}$ leads to

$$-p_0 + p_1 - p_2 + p_3 = 0 \quad \text{and} \quad -p_1 + 2p_2 - 3p_3 = 0$$

- one solution to this system:

$$p_0 = \frac{1 + \sqrt{3}}{4\sqrt{2}}, \quad p_1 = \frac{3 + \sqrt{3}}{4\sqrt{2}}, \quad p_2 = \frac{3 - \sqrt{3}}{4\sqrt{2}}, \quad p_3 = \frac{1 - \sqrt{3}}{4\sqrt{2}}$$

Daubechies Wavelets (D4) – Scaling Function

no analytical expression available → iterative approximation

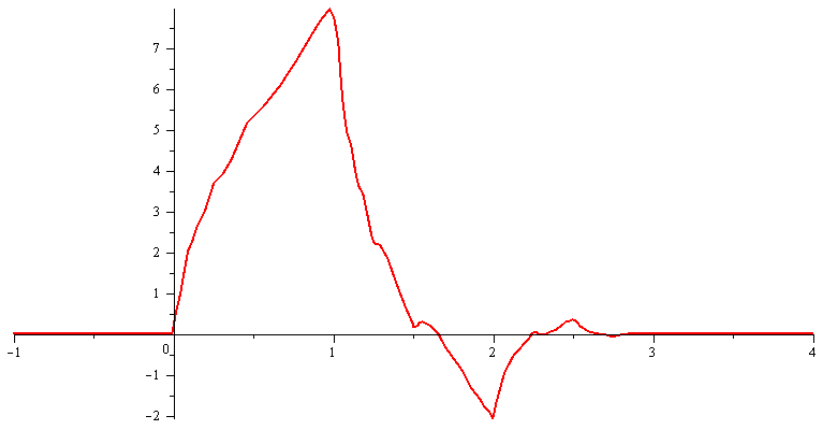

see tutorials: → **“cranking the machine”**

Daubechies Wavelets (D4) – Wavelet Function

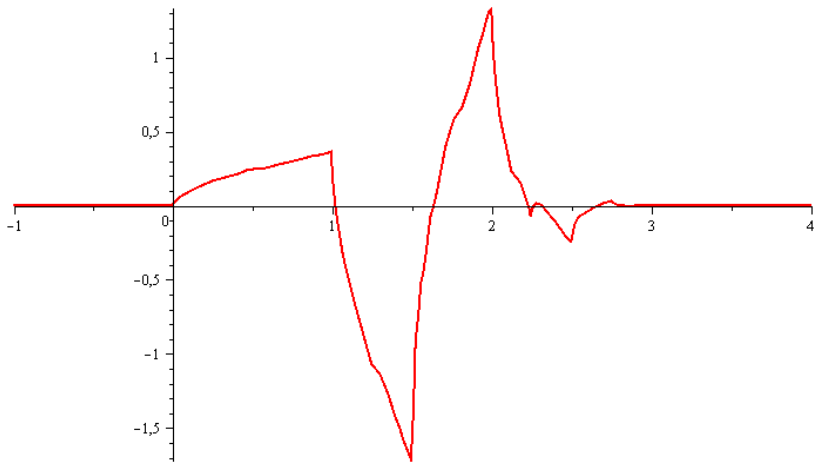

Daubechies Wavelets (D4) – Transform

Algorithm to compute $c_j^{(l)} = \sum_i p_{i-2j} c_i^{(l+1)}$ and $d_j^{(l)} = \sum_i q_{i-2j} c_i^{(l+1)}$ (1 level):

- Input: coefficients $c_i^{(l+1)}$, $i = 0, \dots, 2^{l+1} - 1$ stored in array $c[:]$
- requires helper array $cl[:]$ for $c_j^{(l)}$, $j = 0, \dots, 2^l - 1$
- requires helper array $dl[:]$ for $d_j^{(l)}$, $j = 0, \dots, 2^l - 1$
- filter coefficients p_i and q_i stored in arrays $p[0:3]$ and $q[0:3]$ resp.
- main loop:

```
for j from 0 to 2^l-1 do
    cl[j] = p[0]*c[2*j] + p[1]*c[2*j+1] + p[2]*c[2*j+2] + p[3]*c[2*j+3];
    dl[j] = q[0]*c[2*j] + q[1]*c[2*j+1] + q[2]*c[2*j+2] + q[3]*c[2*j+3];
end do
```

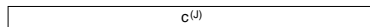

- copy $cl[:]$ and $dl[:]$ into $c[:]$ as in:
- missing: treat boundaries \rightsquigarrow e.g.: periodic wrap-around

Finally: Multiresolution Analysis

Definition: **Multiresolution Analysis**

- nested sequence of function spaces:

$$\dots \subset V_0 \subset V_1 \subset V_2 \subset V_3 \subset \dots$$

- with a scaling function ϕ such that $\phi(2^l x - k)$ is an orthonormal Basis of V_l (and $V_l = \text{span}\{\phi_{l,k} : k \in \mathbb{Z}\}$)
- $\bigcup V_l$ is **dense** in $L^2(\mathbb{R})$
- V_l satisfy **separation property**: $\bigcap V_l = \{0\}$
- $f(t) \in V_l$ if and only if $f(2^{-l}t) \in V_0$

Last but not least: find coefficients c_k such that $s(x) \approx \sum c_k \phi_{l,k}(x)$?

- use orthogonality: $c_k = \langle s(x), \phi_{l,k}(x) \rangle$
(orthogonal projection to space V_l)

References and Further Material

Textbooks:

- E. Aboufadel, S. Schlicker: *Discovering Wavelets*. Wiley, New York, 1999
- I. Daubechies: *Ten Lectures on Wavelets*. CBMS-NSF Regional Conference Series in Applied Mathematics, SIAM, 1992.
- J. S. Walker: *A Primer on Wavelets and their Scientific Applications, Second Edition*. Chapman and Hall/CRC, 2008.

Articles:

- G. Strang: *Wavelet transforms versus Fourier transforms*. Bulletin of the American Mathematical Society 28 (1993), p. 288–305.
- J. S. Walker: *Wavelet-based Image Compression*

See the course webpage for URLs and online access.