

Numerisches Programmieren 2012/13

Christoph Riesinger, Jürgen Bräckle

26. - 29. November 2012

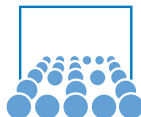

Zuordnung von Signalen zu Frequenzspektren

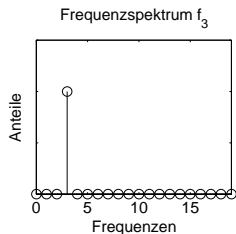
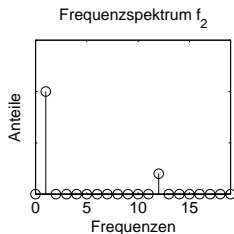
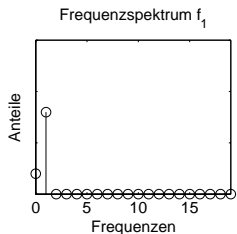
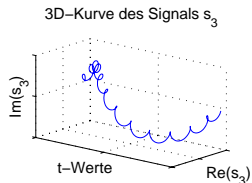
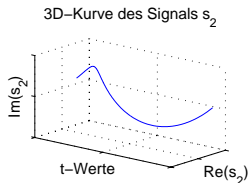
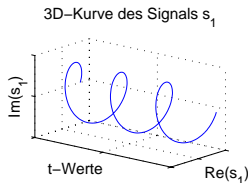

Schema der schnellen Fouriertransformation

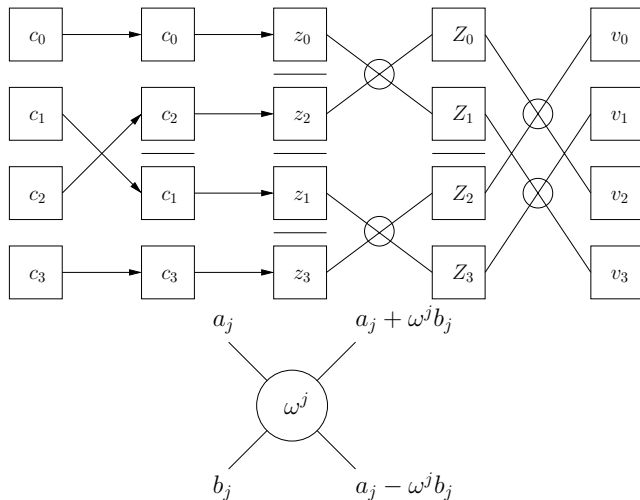

Echo mit Faltung

