

Parallel Programming and High-Performance Computing

Part 7: Examples of Parallel Algorithms

Dr. Ralf-Peter Mundani
CeSIM / IGSSE / CiE
Technische Universität München



7 Examples of Parallel Algorithms

Overview

- matrix operations
- JACOBI and GAUSS-SEIDEL iterations
- sorting

*Everything that can be invented
has been invented.*

— Charles H. Duell
commissioner U.S. Office of Patents, 1899

7 Examples of Parallel Algorithms

Matrix Operations

- reminder: matrix
 - underlying basis for many scientific problems is a matrix
 - stored as 2-dimensional array of numbers (integer, float, double)
 - row-wise in memory (typical case)
 - column-wise in memory
 - typical matrix operations (K : set of numbers)
 - 1) $A + B = C$ with $A, B, \text{ and } C \in K^{N \times M}$
 - 2) $A \cdot b = c$ with $A \in K^{N \times M}$, $b \in K^M$, and $c \in K^N$
 - 3) $A \cdot B = C$ with $A \in K^{N \times M}$, $B \in K^{M \times L}$, and $C \in K^{N \times L}$
 - matrix-vector multiplication (2) and matrix multiplication (3) are main building blocks of numerical algorithms
 - both pretty easy to implement as sequential code
 - what happens in parallel?

7 Examples of Parallel Algorithms

Matrix Operations

- matrix-vector multiplication
 - appearances
 - systems of linear equations (SLE) $A \cdot x = b$
 - iterative methods for solving SLEs (conjugate gradient, e. g.)
 - implementation of neural networks (determination of output values, training neural networks)
 - standard sequential algorithm for $A \in K^{N \times N}$ and $b, c \in K^N$

```
for  $i \leftarrow 1$  to  $N$  do
   $c[i] \leftarrow 0$ ;
  for  $j \leftarrow 1$  to  $N$  do
     $c[i] \leftarrow c[i] + A[i][j] * b[j]$ ;
  od
od
```

- for full matrix A this algorithm has a complexity of $O(N^2)$

7 Examples of Parallel Algorithms

Matrix Operations

- **matrix-vector multiplication (cont'd)**
 - in parallel, there are three main options to distribute data among P procs
 - *row-wise block-striped decomposition*: each process is responsible for a contiguous part of about N/P rows of A
 - *column-wise block-striped decomposition*: each process is responsible for a contiguous part of about N/P columns of A
 - *checkerboard block decomposition*: each process is responsible for a contiguous block of matrix elements
 - vector b may be either replicated or block-decomposed itself

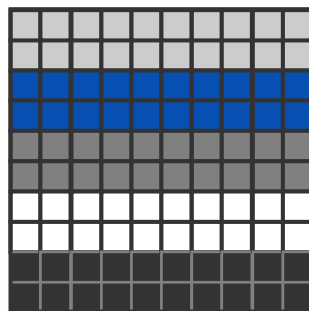

row-wise

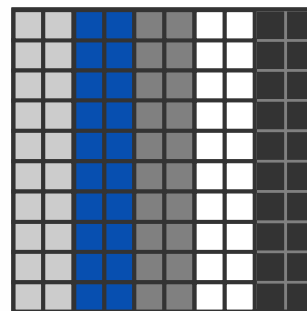

column-wise

checkerboard

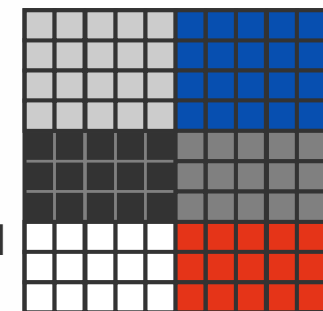

7 Examples of Parallel Algorithms

Matrix Operations

- matrix-vector multiplication (cont'd)
 - row-wise block-striped decomposition
 - probably the most straightforward approach
 - each process gets some rows of A and entire vector b
 - each process computes some components of vector c
 - build and replicate entire vector c (gather-to-all, e. g.)
 - complexity of $O(N^2/P)$ multiplications / additions for P processes

$$\begin{pmatrix} \cdot & \cdot & \cdot & \cdot & \cdot \\ \cdot & \cdot & \cdot & \cdot & \cdot \\ \bullet & \bullet & \bullet & \bullet & \bullet \\ \bullet & \bullet & \bullet & \bullet & \bullet \\ \cdot & \cdot & \cdot & \cdot & \cdot \\ \cdot & \cdot & \cdot & \cdot & \cdot \end{pmatrix} \cdot \begin{pmatrix} \bullet \\ \bullet \\ \bullet \\ \bullet \\ \bullet \end{pmatrix} = \begin{pmatrix} \cdot \\ \cdot \\ \bullet \\ \bullet \\ \cdot \\ \cdot \end{pmatrix}$$

7 Examples of Parallel Algorithms

Matrix Operations

- matrix-vector multiplication (cont'd)
 - column-wise block-striped decomposition
 - less straightforward approach
 - each process gets some columns of A and respective elements of vector b
 - each process computes partial results of vector c
 - build and replicate entire vector c (all-reduce or maybe a reduce-scatter if processes do not need entire vector c)
 - complexity is comparable to row-wise approach

$$\begin{pmatrix} \cdot & \bullet & \bullet & \cdot & \cdot \\ \cdot & \bullet & \bullet & \cdot & \cdot \\ \cdot & \bullet & \bullet & \cdot & \cdot \\ \cdot & \bullet & \bullet & \cdot & \cdot \\ \cdot & \bullet & \bullet & \cdot & \cdot \\ \cdot & \bullet & \bullet & \cdot & \cdot \end{pmatrix} \cdot \begin{pmatrix} \cdot \\ \bullet \\ \bullet \\ \cdot \\ \cdot \end{pmatrix} = \begin{pmatrix} \circ \\ \circ \\ \circ \\ \circ \\ \circ \\ \circ \end{pmatrix}$$

7 Examples of Parallel Algorithms

Matrix Operations

- matrix-vector multiplication (cont'd)
 - checkerboard block decomposition
 - each process gets some block of elements of A and respective elements of vector b
 - each process computes some partial results of vector c
 - build and replicate entire vector c (all-reduce, but “unused” elements of vector c have to be initialised with zero)
 - complexity of the same order as before; it can be shown that checkerboard approach has slightly better scalability properties (increasing P does not require to increase N , too)

$$\begin{pmatrix} \bullet & \bullet & \bullet & \cdot & \cdot \\ \bullet & \bullet & \bullet & \cdot & \cdot \\ \bullet & \bullet & \bullet & \cdot & \cdot \\ \cdot & \cdot & \cdot & \cdot & \cdot \\ \cdot & \cdot & \cdot & \cdot & \cdot \\ \cdot & \cdot & \cdot & \cdot & \cdot \end{pmatrix} \cdot \begin{pmatrix} \bullet \\ \bullet \\ \bullet \\ \cdot \\ \cdot \end{pmatrix} = \begin{pmatrix} \circ \\ \circ \\ \circ \\ \cdot \\ \cdot \\ \cdot \end{pmatrix}$$

7 Examples of Parallel Algorithms

Matrix Operations

- matrix multiplication
 - appearances
 - computational chemistry (computing changes of state, e. g.)
 - signal processing (DFT, e. g.)
 - standard sequential algorithm for $A, B, C \in K^{N \times N}$

```
for  $i \leftarrow 1$  to  $N$  do
  for  $j \leftarrow 1$  to  $N$  do
     $C[i][j] \leftarrow 0$ 
    for  $k \leftarrow 1$  to  $N$  do
       $C[i][j] \leftarrow C[i][j] + A[i][k]*B[k][j];$ 
    od
  od
od
```

- for full matrices A and B this algorithm has a complexity of $O(N^3)$

7 Examples of Parallel Algorithms

Matrix Operations

- matrix multiplication (cont'd)
 - naïve parallelisation
 - each process gets some rows of A and entire matrix B
 - each process computes some rows of C

$$\begin{pmatrix} \cdot & \cdot & \cdot & \cdot & \cdot & \cdot \\ \cdot & \cdot & \cdot & \cdot & \cdot & \cdot \\ \bullet & \bullet & \bullet & \bullet & \bullet & \bullet \\ \bullet & \bullet & \bullet & \bullet & \bullet & \bullet \\ \cdot & \cdot & \cdot & \cdot & \cdot & \cdot \\ \cdot & \cdot & \cdot & \cdot & \cdot & \cdot \end{pmatrix} \cdot \begin{pmatrix} \bullet & \bullet & \bullet & \bullet & \bullet & \bullet \\ \bullet & \bullet & \bullet & \bullet & \bullet & \bullet \\ \bullet & \bullet & \bullet & \bullet & \bullet & \bullet \\ \bullet & \bullet & \bullet & \bullet & \bullet & \bullet \\ \bullet & \bullet & \bullet & \bullet & \bullet & \bullet \\ \bullet & \bullet & \bullet & \bullet & \bullet & \bullet \end{pmatrix} = \begin{pmatrix} \cdot & \cdot & \cdot & \cdot & \cdot & \cdot \\ \cdot & \cdot & \cdot & \cdot & \cdot & \cdot \\ \bullet & \bullet & \bullet & \bullet & \bullet & \bullet \\ \bullet & \bullet & \bullet & \bullet & \bullet & \bullet \\ \cdot & \cdot & \cdot & \cdot & \cdot & \cdot \\ \cdot & \cdot & \cdot & \cdot & \cdot & \cdot \end{pmatrix}$$

- problem: once N reaches a certain size, matrix B won't fit completely into cache and / or memory \rightarrow performance will dramatically decrease
- remedy: subdivision of matrix B instead of whole matrix B

7 Examples of Parallel Algorithms

Matrix Operations

- matrix multiplication (cont'd)
 - recursive algorithm
 - algorithm follows the divide-and-conquer principle
 - subdivide both matrices A and B into four smaller submatrices

$$A = \begin{pmatrix} A_{00} & A_{01} \\ A_{10} & A_{11} \end{pmatrix} \quad B = \begin{pmatrix} B_{00} & B_{01} \\ B_{10} & B_{11} \end{pmatrix}$$

- hence, the matrix multiplication can be computed as follows

$$C = \begin{pmatrix} A_{00} \cdot B_{00} + A_{01} \cdot B_{10} & A_{00} \cdot B_{01} + A_{01} \cdot B_{11} \\ A_{10} \cdot B_{00} + A_{11} \cdot B_{10} & A_{10} \cdot B_{01} + A_{11} \cdot B_{11} \end{pmatrix}$$

- if blocks are still too large for the cache, repeat this step (i. e. recursively subdivide) until it fits
- furthermore, this method has significant potential for parallelisation (especially for MemMS)

7 Examples of Parallel Algorithms

Matrix Operations

- matrix multiplication (cont'd)
 - CANNON's algorithm
 - each process gets some rows of A and some columns of B
 - each process computes some components of matrix C
 - different possibilities for assembling the result
 - gather all data, build and (maybe) replicate matrix C
 - “pump” data onward to next process (→ systolic array)
 - complexity of $O(N^3/P)$ multiplications / additions for P processes

$$\begin{pmatrix} \cdot & \cdot & \cdot & \cdot & \cdot & \cdot \\ \bullet & \bullet & \bullet & \bullet & \bullet & \bullet \\ \bullet & \bullet & \bullet & \bullet & \bullet & \bullet \\ \cdot & \cdot & \cdot & \cdot & \cdot & \cdot \\ \cdot & \cdot & \cdot & \cdot & \cdot & \cdot \\ \cdot & \cdot & \cdot & \cdot & \cdot & \cdot \end{pmatrix} \cdot \begin{pmatrix} \cdot & \bullet & \bullet & \cdot & \cdot & \cdot \\ \cdot & \bullet & \bullet & \cdot & \cdot & \cdot \\ \cdot & \bullet & \bullet & \cdot & \cdot & \cdot \\ \cdot & \bullet & \bullet & \cdot & \cdot & \cdot \\ \cdot & \bullet & \bullet & \cdot & \cdot & \cdot \\ \cdot & \bullet & \bullet & \cdot & \cdot & \cdot \end{pmatrix} = \begin{pmatrix} \cdot & \cdot & \cdot & \cdot & \cdot & \cdot \\ \cdot & \bullet & \bullet & \cdot & \cdot & \cdot \\ \cdot & \bullet & \bullet & \cdot & \cdot & \cdot \\ \cdot & \cdot & \cdot & \cdot & \cdot & \cdot \\ \cdot & \cdot & \cdot & \cdot & \cdot & \cdot \\ \cdot & \cdot & \cdot & \cdot & \cdot & \cdot \end{pmatrix}$$

7 Examples of Parallel Algorithms

Overview

- matrix operations
- JACOBI and GAUSS-SEIDEL iterations
- sorting

7 Examples of Parallel Algorithms

JACOBI and GAUSS-SEIDEL Iterations

- scenario

- solve an elliptic partial differential equation (PDE) with DIRICHLET boundary conditions on a given domain Ω
- simple example: POISSON equation $-\Delta u = f$

$$(1) \quad -\Delta u(x,y) = -\frac{\partial^2 u(x,y)}{\partial x^2} - \frac{\partial^2 u(x,y)}{\partial y^2} = f(x,y) \quad \text{for } (x,y) \in \Omega$$

on the unit square $\Omega =]0,1[^2$ with u given on the boundary of Ω

- task: $u(x,y)$ or an approximation to it has to be found
- occurrences of such PDEs
 - fixed membrane
 - stationary heat equation (picture)
 - electrostatic fields
 - ...

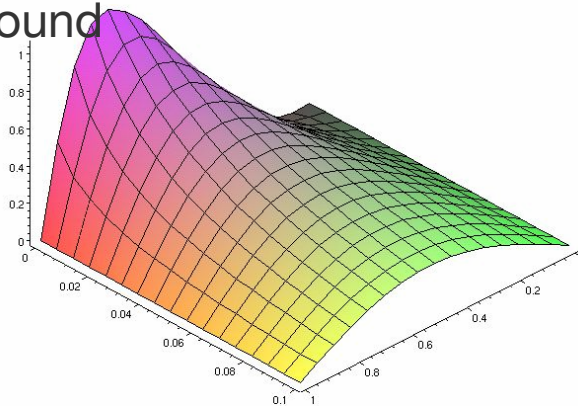

7 Examples of Parallel Algorithms

JACOBI and GAUSS-SEIDEL Iterations

- discretisation
 - for solving our example PDE, a discretisation is necessary
 - typical discretisation techniques
 - finite differences
 - finite volumes
 - finite elements
 - finite difference discretisation (forward and backward differences) for the second derivatives in (1) for a mesh width h leads to

$$(2) \quad \frac{\partial^2 u(x, y)}{\partial x^2} \approx \frac{u(x-h, y) - 2u(x, y) + u(x+h, y)}{h^2}$$

$$\frac{\partial^2 u(x, y)}{\partial y^2} \approx \frac{u(x, y-h) - 2u(x, y) + u(x, y+h)}{h^2}$$

7 Examples of Parallel Algorithms

JACOBI and GAUSS-SEIDEL Iterations

- discretisation (cont'd)
 - for computational solution of our problem a 2D grid is necessary
 - equidistant grid with $(N+1) \times (N+1)$ grid points, $N = 1/h$
 - $u_{i,j} \approx u(i \cdot h, j \cdot h)$ with $i, j = 0, \dots, N$
 - hence, (2) can be written as

$$(3) \quad \frac{\partial^2 u(x,y)}{\partial x^2} \approx \frac{u_{i-1,j} - 2u_{i,j} + u_{i+1,j}}{h^2}, \quad \frac{\partial^2 u(x,y)}{\partial y^2} \approx \frac{u_{i,j-1} - 2u_{i,j} + u_{i,j+1}}{h^2}$$

- with (3) and an appropriate discretisation of $f(x,y)$ follows

$$(4) \quad -u_{i-1,j} - u_{i,j-1} + 4u_{i,j} - u_{i+1,j} - u_{i,j+1} = h^2 \cdot f_{i,j} \quad 0 < i, j < N$$

- resulting equation on the boundary

$$u_{i,j} = g_{i,j} \quad i, j = 0 \text{ or } i, j = N$$

- inner point
- boundary point

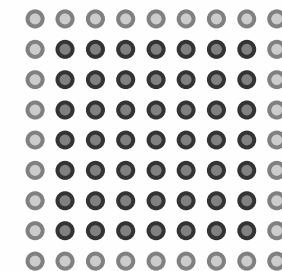

7 Examples of Parallel Algorithms

JACOBI and GAUSS-SEIDEL Iterations

- system of linear equations
 - for each inner point there is one linear equation according to (4)
 - equations in points next to the boundary (i. e. $i, j = 1$ or $i, j = N-1$) access boundary values $g_{i,j}$
 - these are shifted to the right-hand side of the equation
 - hence, all unknowns are located left, all known quantities right
 - assembling of the overall vector of unknowns by lexicographic row-wise ordering

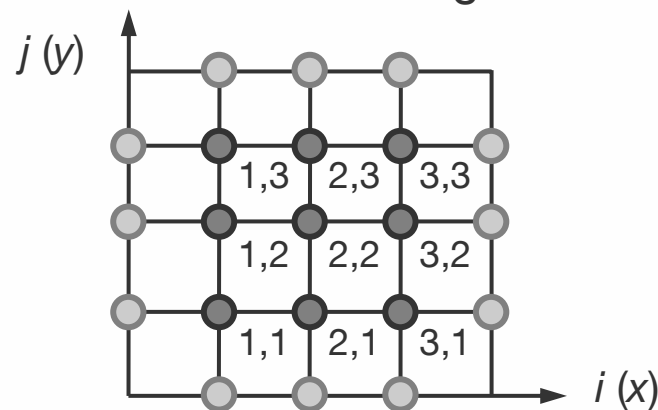

5-point difference star

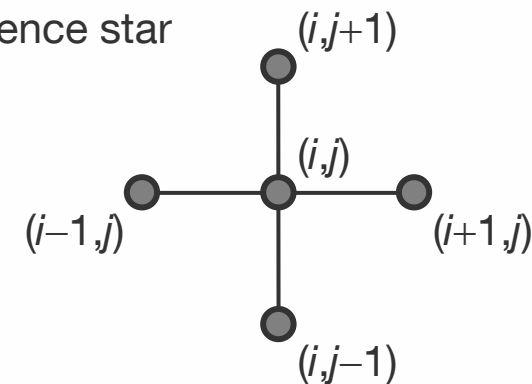

7 Examples of Parallel Algorithms

JACOBI and GAUSS-SEIDEL Iterations

- system of linear equations (cont'd)
 - this results to a system of linear equations $A \cdot x = b$
 - with $(N-1)^2$ equations in $(N-1)^2$ unknowns
 - matrix A has block-tridiagonal structure and is sparse

$$(5) \quad \underbrace{\begin{pmatrix} 4 & -1 & & & -1 \\ -1 & 4 & -1 & & \\ & & \ddots & & \\ -1 & & \ddots & \ddots & \ddots & \\ & \ddots & & & & -1 \\ & & & & & & -1 & 4 & -1 \\ & & & & & & -1 & -1 & 4 \end{pmatrix}}_{= A} \cdot \underbrace{\begin{pmatrix} u_{1,1} \\ \vdots \\ u_{N-1,1} \\ u_{1,2} \\ \vdots \\ \vdots \\ u_{N-1,N-1} \end{pmatrix}}_{= x} = \underbrace{\begin{pmatrix} f_{1,1} \\ \vdots \\ f_{N-1,1} \\ f_{1,2} \\ \vdots \\ \vdots \\ f_{N-1,N-1} \end{pmatrix}}_{= b}$$

7 Examples of Parallel Algorithms

JACOBI and GAUSS-SEIDEL Iterations

- solving large sparse SLEs
 - schoolbook method for solving SLEs: GAUSSIAN elimination
 - direct solver that provides the exact solution
 - has a complexity of $O(M^3)$ for M unknowns (!)
 - does not exploit sparsity of matrix A that is even filled-up (i. e. existing zeros are “destroyed”) during solution
 - hence, using some iterative method instead
 - approximates the exact solution
 - has a complexity of $O(M)$ operations for a single iteration
 - typically much less than $O(M^2)$ iteration steps needed → ideal case of $O(1)$ steps for *multigrid* or *multilevel* methods
 - basic methods (number of steps depending on M)
 - relaxation methods: JACOBI, GAUSS-SEIDEL, SOR
 - minimisation methods: steepest descent, CG

7 Examples of Parallel Algorithms

JACOBI and GAUSS-SEIDEL Iterations

- JACOBI iteration

- decompose matrix A in its diagonal part D_A , its upper triangular part U_A , and its lower triangular part L_A

$$A = L_A + D_A + U_A$$

- starting with

$$b = A \cdot x = D_A \cdot x + (L_A + U_A) \cdot x$$

and writing $b = D_A \cdot x^{(T+1)} + (L_A + U_A) \cdot x^{(T)}$ with $x^{(T)}$ denoting the approximation to x after T steps of the iteration leads to the following iterative scheme

$$x^{(T+1)} = -D_A^{-1} \cdot (L_A + U_A) \cdot x^{(T)} + D_A^{-1} \cdot b = x^{(T)} + D_A^{-1} \cdot r^{(T)}$$

where the residual is defined as $r^{(T)} = b - A \cdot x^{(T)}$

7 Examples of Parallel Algorithms

JACOBI and GAUSS-SEIDEL Iterations

- JACOBI iteration (cont'd)
 - algorithmic form of the JACOBI iteration

```

for  $T \leftarrow 0, 1, 2, \dots$  do
  for  $k \leftarrow 1$  to  $M$  do
     $\mathbf{x}_k^{(T+1)} \leftarrow 1/A_{k,k} * (b_k - \sum_{j \neq k} A_{k,j} * \mathbf{x}_j^{(T)})$ 
  od
od

```

- for our example with matrix A according to (5) this means

```

for  $T \leftarrow 0, 1, 2, \dots$  do
  for  $j \leftarrow 1$  to  $N-1$  do
    for  $i \leftarrow 1$  to  $N-1$  do
       $u_{i,j}^{(T+1)} \leftarrow 1/4 * (u_{i-1,j}^{(T)} + u_{i,j-1}^{(T)} + u_{i+1,j}^{(T)} + u_{i,j+1}^{(T)} - h^2 * f_{i,j})$ 
    od
  od
od

```

7 Examples of Parallel Algorithms

JACOBI and GAUSS-SEIDEL Iterations

- GAUSS-SEIDEL iteration
 - same decomposition of matrix A as for JACOBI

$$A = L_A + D_A + U_A$$

- starting with

$$b = A \cdot x = (D_A + L_A) \cdot x + U_A \cdot x$$

and writing $b = (D_A + L_A) \cdot x^{(T+1)} + U_A \cdot x^{(T)}$ leads to the following iterative scheme

$$x^{(T+1)} = -(D_A + L_A)^{-1} \cdot U_A \cdot x^{(T)} + (D_A + L_A)^{-1} \cdot b = x^{(T)} + (D_A + L_A)^{-1} \cdot r^{(T)}$$

where the residual is defined as $r^{(T)} = b - A \cdot x^{(T)}$

7 Examples of Parallel Algorithms

JACOBI and GAUSS-SEIDEL Iterations

- GAUSS-SEIDEL iteration (cont'd)

- algorithmic form of the GAUSS-SEIDEL iteration

```
for T ← 0, 1, 2, ... do
```

```
  for k ← 1 to M do
```

$$\mathbf{x}_k^{(T+1)} \leftarrow 1/A_{k,k} * (b_k - \sum_{j < k} A_{k,j} * \mathbf{x}_j^{(T+1)} - \sum_{j > k} A_{k,j} * \mathbf{x}_j^{(T)})$$

```
  od
```

```
od
```

- for our example with matrix A according to (5) this means

```
for T ← 0, 1, 2, ... do
```

```
  for j ← 1 to N-1 do
```

```
    for i ← 1 to N-1 do
```

$$u_{i,j}^{(T+1)} \leftarrow 1/4 * (u_{i-1,j}^{(T+1)} + u_{i,j-1}^{(T+1)} + u_{i+1,j}^{(T)} + u_{i,j+1}^{(T)} - h^2 * f_{i,j})$$

```
    od
```

```
  od
```

```
od
```

7 Examples of Parallel Algorithms

JACOBI and GAUSS-SEIDEL Iterations

- parallelisation of JACOBI iteration
 - neither JACOBI nor GAUSS-SEIDEL are used today very frequently for solving large SLEs (they are too slow)
 - nevertheless, the algorithmic aspects are still of interest
 - a parallel JACOBI is quite straightforward
 - in iteration step T only values from step $T-1$ are used
 - hence, all updates of one step can be made in parallel
 - furthermore, subdivide the domain into strips or blocks, e. g.

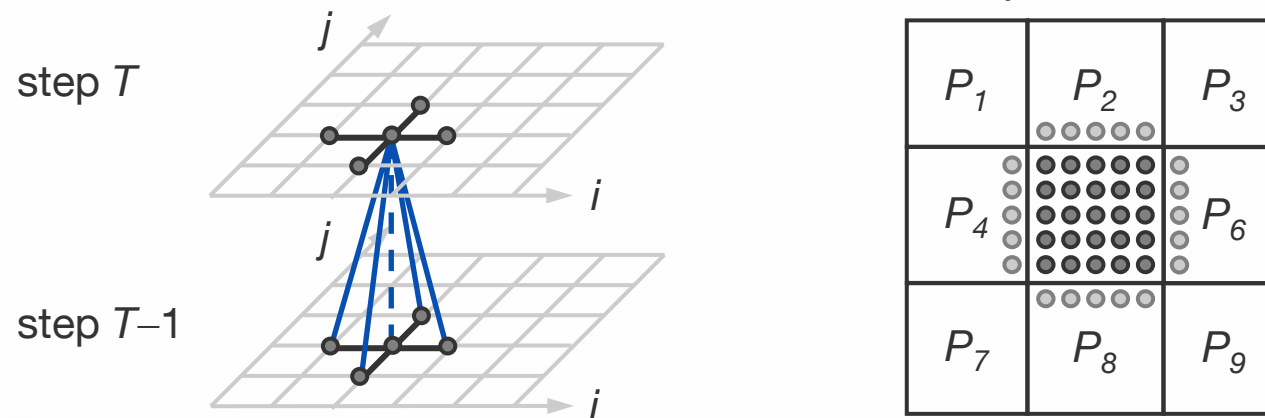

7 Examples of Parallel Algorithms

JACOBI and GAUSS-SEIDEL Iterations

- parallelisation of JACOBI iteration (cont'd)
 - for its computations, each processor P needs
 - a subset of boundary values (if P is adjacent to the boundary)
 - one row / column of values from P 's neighbouring processes
 - a global / local termination condition
 - hence, each processor has to execute the following algorithm
 - 1) update all local approximate values $u_{i,j}^{(T)}$ to $u_{i,j}^{(T+1)}$
 - 2) send all updates (●) to the respective neighbouring processes
 - 3) receive all necessary updates (○) from neighbouring processes
 - 4) compute local residual values and perform a reduce-all for global residual
 - 5) continue if global residual is larger than some threshold value ε

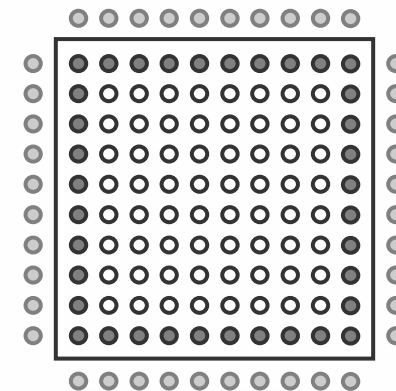

7 Examples of Parallel Algorithms

JACOBI and GAUSS-SEIDEL Iterations

- parallelisation of GAUSS-SEIDEL iteration
 - problem: since the updated values are immediately used where available, parallelisation seems to be quite complicated

- updated values (step T)
- old values (step $T-1$)

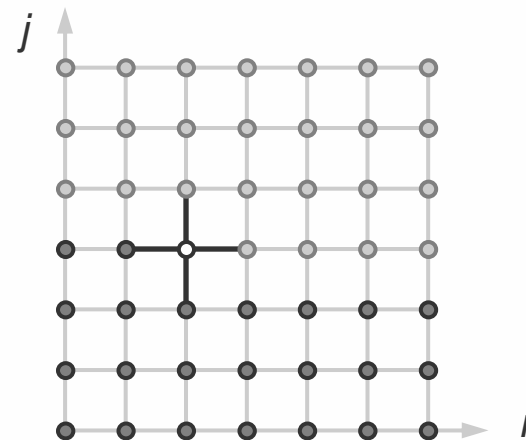

- hence, a different order of visiting / updating the grid points is necessary
 - wavefront ordering
 - red-black or checkerboard ordering

7 Examples of Parallel Algorithms

JACOBI and GAUSS-SEIDEL Iterations

- parallelisation of GAUSS-SEIDEL iteration (cont'd)
 - wavefront ordering (1)
 - diagonal ordering of updates → all values along a diagonal line can be updated in parallel; single diagonal lines still have to be processed sequentially
 - problem: for $P = N$ processors there are P^2 updates that need $2P-1$ sequential steps → speed-up restricted to $P/2$

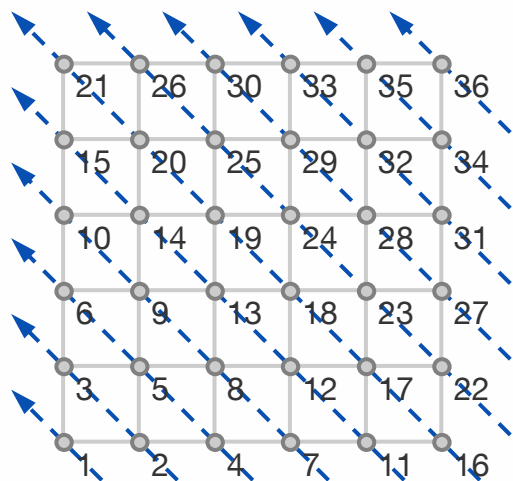

$P_1:$	1	2	4	7	11	16	22	27	31	34	36
$P_2:$		3	5	8	12	17	23	28	32	35	
$P_3:$			6	9	13	18	24	29	33		
$P_4:$				10	14	19	25	30			
$P_5:$					15	20	26				
$P_6:$						21					

7 Examples of Parallel Algorithms

JACOBI and GAUSS-SEIDEL Iterations

- parallelisation of GAUSS-SEIDEL iteration (cont'd)
 - wavefront ordering (2)
 - better
 - row-wise decomposition of matrix A in K blocks of N/K rows
 - for $P = N/K$ processors there are K sequential blocks of $K \cdot P^2$ updates that need $K \cdot P + P - 1$ sequential steps each
 - hence, speed-up restricted to $K \cdot P / (K + 1)$

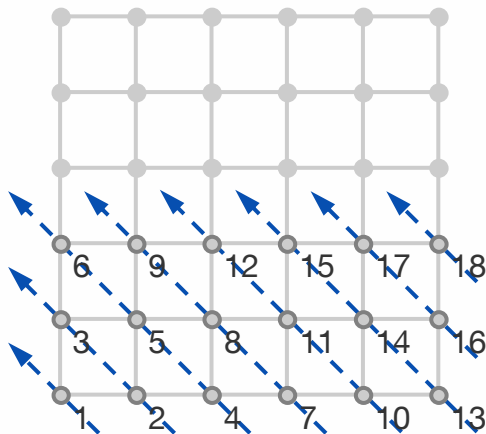

P_1 :	1	2	4	7	10	13	16	18
P_2 :		3	5	8	11	14	17	
P_3 :			6	9	12	15		

here, $K = 2 \rightarrow$ speed-up $S(p) = 2P/3$

7 Examples of Parallel Algorithms

JACOBI and GAUSS-SEIDEL Iterations

- parallelisation of GAUSS-SEIDEL iteration (cont'd)
 - red-black or checkerboard ordering
 - grid points get a checkerboard colouring of red and black
 - lexicographic order of visiting / updating the grid points
 - first the red ones, then the black ones
 - hence, no dependencies within red nor within black set
 - subdivide grid such that each processor gets some red and some black points → two sequential steps necessary, but perfect parallelism within each of them

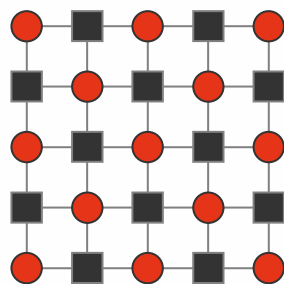

red-black ordering

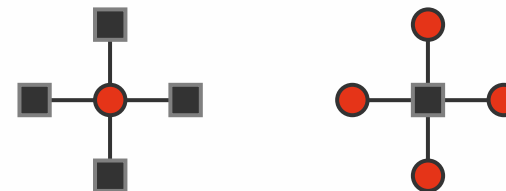

5-point star for red (left) and black (right) grid points

7 Examples of Parallel Algorithms

Overview

- matrix operations
- JACOBI and GAUSS-SEIDEL iterations
- sorting

7 Examples of Parallel Algorithms

Sorting

- reminder: sorting
 - one of the most common operations performed by computers
 - let $A = \langle a_1, a_2, \dots, a_N \rangle$ be a sequence of N elements in arbitrary order
 - sorting transforms A into a monotonically increasing or decreasing sequence $\tilde{A} = \langle \tilde{a}_1, \tilde{a}_2, \dots, \tilde{a}_N \rangle$ such that
 - $\tilde{a}_i \leq \tilde{a}_j$ for $1 \leq i \leq j \leq N$ (*increasing order*)
 - $\tilde{a}_i \geq \tilde{a}_j$ for $1 \leq i \leq j \leq N$ (*decreasing order*)

and \tilde{A} being a permutation of A

- in general, sorting algorithms are comparison-based, i. e. an algorithm sorts an unordered sequence of elements by repeatedly comparing / exchanging pairs of elements
- lower bound of the sequential complexity of any comparison-based algorithm is $O(N \cdot \log N)$

7 Examples of Parallel Algorithms

Sorting

- basic operations
 - in sequential / parallel sorting algorithms, some basic operations are repeatedly executed
 - *compare-exchange*: elements a_i and a_j are compared and exchanged in case they are out of sequence
 - *compare-split*: already sorted blocks of elements A_i and A_j stored at different processors P_i and P_j , resp., are merged and split in the following manner

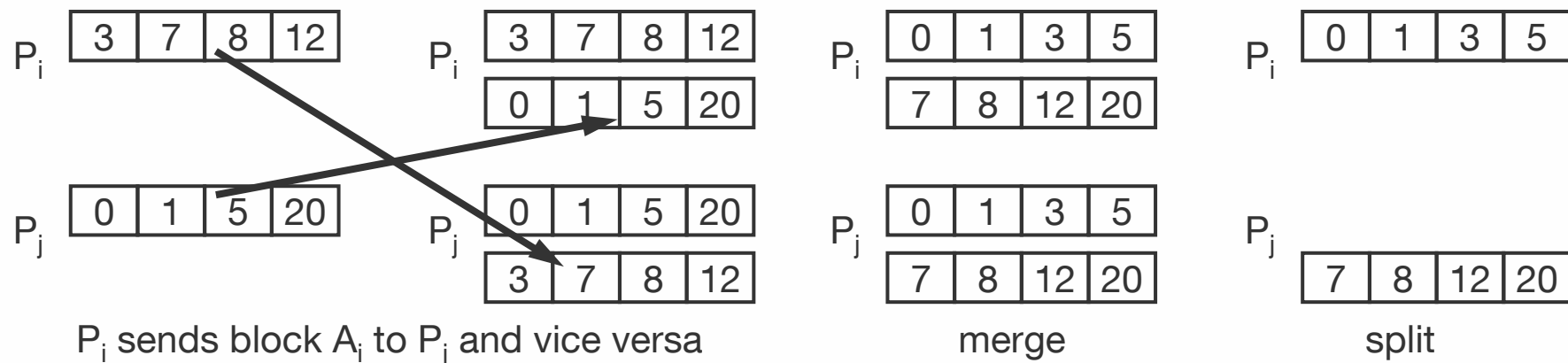

7 Examples of Parallel Algorithms

Sorting

- bubble sort
 - simple comparison-based sorting algorithm of complexity $O(N^2)$
 - standard sequential algorithm for sorting sequence A

```
for (i = N-1; i ≥ 1; --i) {
  for (j = 0; j < i; ++j) {
    compare-exchange (a[j], a[j+1]);
  }
}
```

- example: iterations $i = 1, 2, 3$ for sorting $A = \langle 3, 2, 3, 8, 5, 6, 4, 1 \rangle$

initial setup	3	2	3	8	5	6	4	1
1st iteration	2	3	3	5	6	4	1	8
2nd iteration	2	3	3	5	4	1	6	8
3rd iteration	2	3	3	4	1	5	6	8

7 Examples of Parallel Algorithms

Sorting

- bubble sort (cont'd)
 - standard algorithm not very suitable for parallelisation → partition of A into blocks of size N/P elements (for P processors) still to be processed sequentially
 - hence, different approach necessary: *odd-even transposition*
 - idea: sorting N elements (N is even) in N phases, each of which requires $N/2$ compare-exchange operations → alternation between two phases, called odd and even phase
 - during odd phase, only elements with odd indices are compare-exchanged with their right neighbours, thus, the pairs (a_1, a_2) , (a_3, a_4) , (a_5, a_6) , ..., (a_{N-1}, a_N)
 - during even phase, only elements with even indices are compare-exchanged with their right neighbours, thus, the pairs (a_2, a_3) , (a_4, a_5) , (a_6, a_7) , ..., (a_{N-2}, a_{N-1})
 - after N phases of odd-even-exchanges, sequence A is sorted

7 Examples of Parallel Algorithms

Sorting

- bubble sort (cont'd)
 - example: odd-even-transposition for sorting A from before

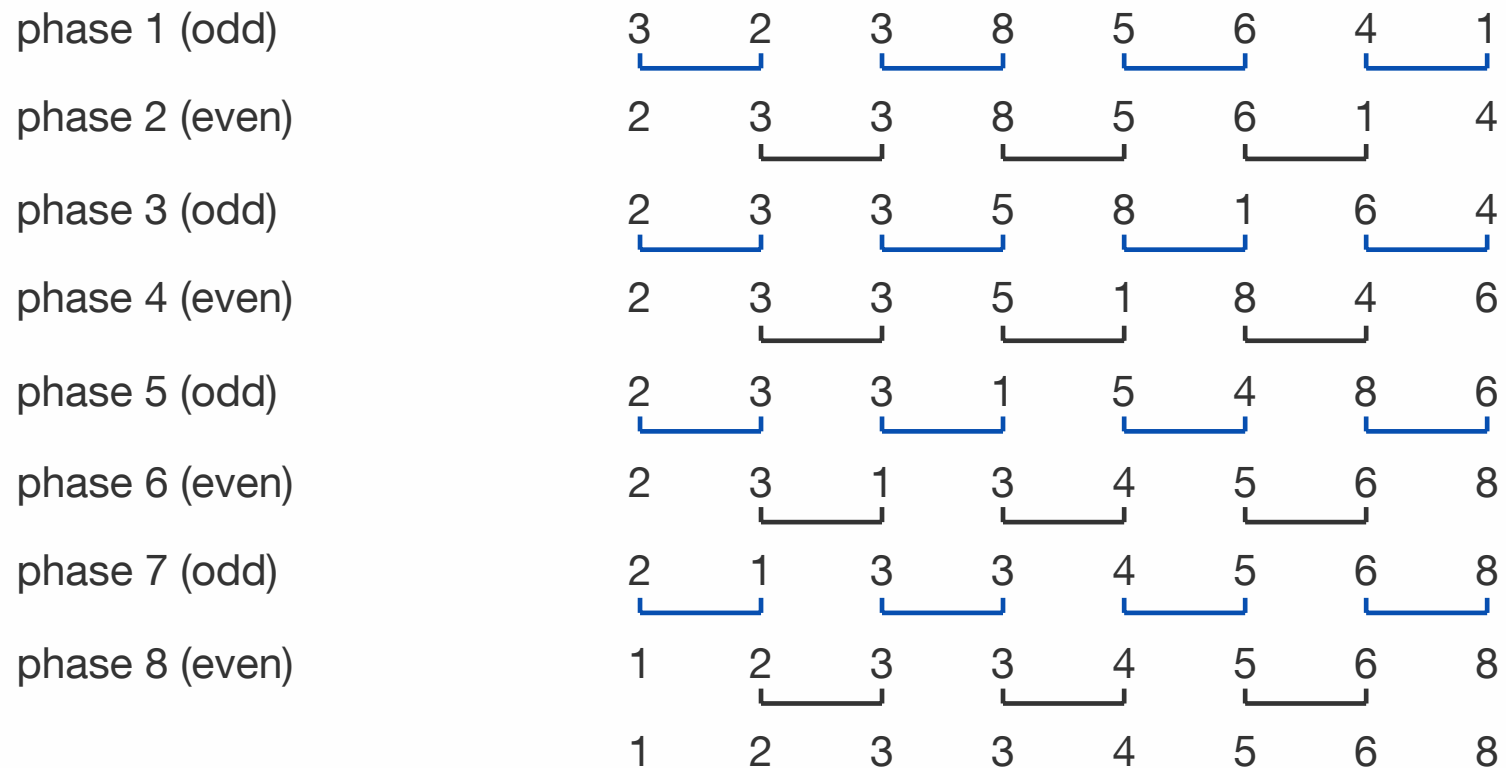

7 Examples of Parallel Algorithms

Sorting

- bubble sort (cont'd)
 - parallelisation of odd-even-transposition
 - each process is assigned a block of N/P elements, which are sorted internally (using merge sort or quicksort, e. g.) with a complexity of $O((N/P) \cdot \log(N/P))$
 - afterwards, each processor executes P phases ($P/2$ odd and $P/2$ even ones), performing compare-split operations
 - at the end of these phases, sequence A is sorted (and distributed stored over P processes where process P_i holds block A_i with $A_i \leq A_j$ for $i < j$)
 - during each phase $O(N/P)$ comparisons are performed, thus, the total complexity of the parallel sort can be computed as

$$\underbrace{O((N/P) \cdot \log(N/P))}_{\text{local sort}} + \underbrace{O(N)}_{\text{comparisons}} + \text{communication}$$

7 Examples of Parallel Algorithms

Sorting

- merge sort
 - comparison-based sorting algorithm of complexity $O(N \cdot \log N)$
 - based on the divide-and-conquer strategy
 - basic idea: construct a sorted list by merging two sorted lists
 - 1) divide unsorted list into two sublists of about half the size
 - 2) recursively divide sublists until list size equals one
 - 3) merge the two sorted sublists back into one sorted list

```
function mergesort (list L) {  
    if (size of L == 1) return L;  
    else  
        divide L into left and right list;  
        left = mergesort (left);  
        right = mergesort (right);  
        result = merge (left, right);  
        return result;  
}
```

7 Examples of Parallel Algorithms

Sorting

- merge sort (cont'd)
 - example: merge sort for sequence $A = \langle 8, 3, 5, 2, 3, 6, 4, 1 \rangle$

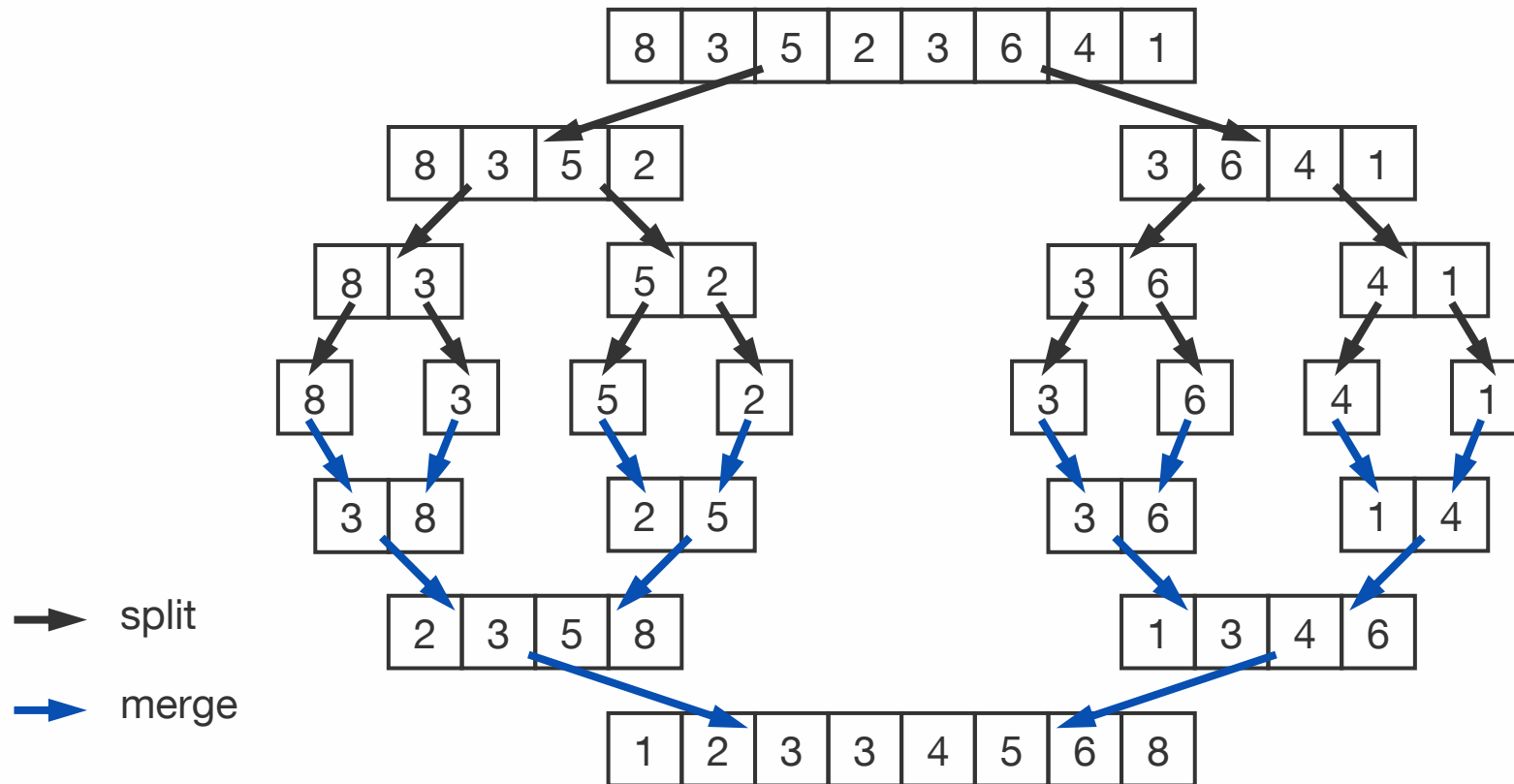

7 Examples of Parallel Algorithms

Sorting

- merge sort (cont'd)
 - parallelisation of merge sort: *naïve approach*
 - construct a binary processing tree of L leaf nodes and assign P processors, $P \geq L$, to tree nodes (i. e. inner and leaf nodes)
 - divide sequence A into blocks A_i of size N/L and store them at leaf nodes
 - parallel sort of blocks A_i via sequential merge sort with a complexity of $O((N/L) \cdot \log(N/L))$
 - repeatedly parallel merge of sorted sublists from child nodes and sending result upstream to parent node with a total complexity of $O(N)$ (costs of merge operation at the different tree levels are $N + N/2 + N/4 + \dots + N/L$ comparisons)
 - problem: sending of sublists might induce heavy communication
 - hence, an appropriate mapping of processors to tree nodes is indispensable

7 Examples of Parallel Algorithms

Sorting

- merge sort (cont'd)
 - example: mapping of processors to tree nodes for $P = L = 8$

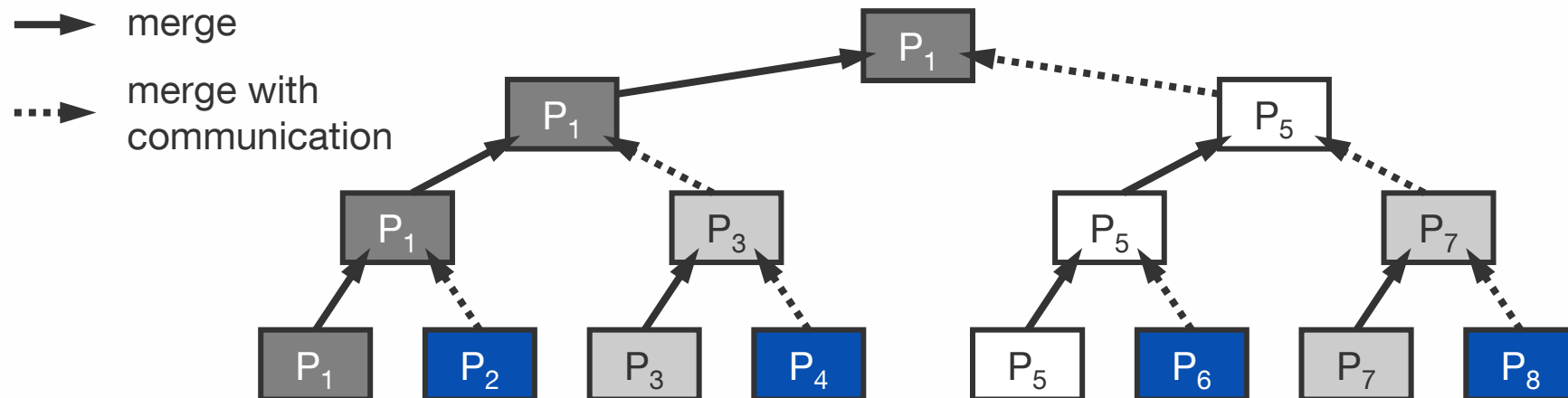

- observations: not to expect very good speed-up values for parallel merge of sublists (amount of used processors is halved in every step → part 1: parallel index and estimate of MINSKY)
- hence, different strategy for parallel merge necessary

7 Examples of Parallel Algorithms

Sorting

- sorting networks
 - sorting networks are based on a comparison network model, that sort N elements in significantly smaller than $O(N \cdot \log N)$ operations
 - key component of a sorting network: comparator
 - device with two inputs a_1, a_2 and two outputs \tilde{a}_1, \tilde{a}_2
 - *increasing comparator*: $\tilde{a}_1 = \min\{a_1, a_2\}$ and $\tilde{a}_2 = \max\{a_1, a_2\}$
 - *decreasing comparator*: $\tilde{a}_1 = \max\{a_1, a_2\}$ and $\tilde{a}_2 = \min\{a_1, a_2\}$
 - sorting networks consist of several columns of such comparators, where each column performs a permutation, thus the final column is sorted in increasing / decreasing order (\rightarrow permutation networks)

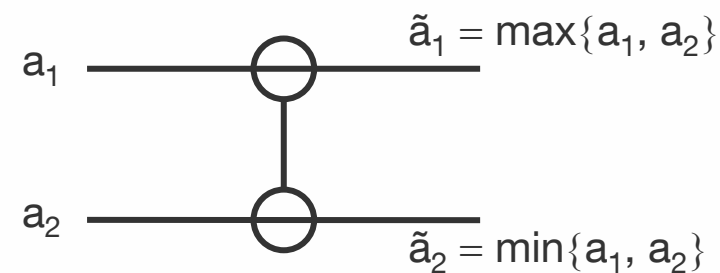
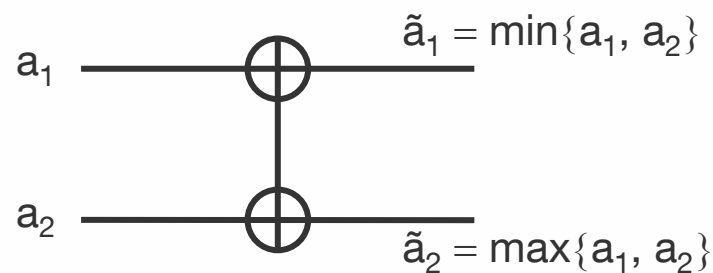

7 Examples of Parallel Algorithms

Sorting

- bitonic sort
 - a bitonic sorting network sorts N elements in $O(\log^2 N)$ operations
 - key task: rearrangement of a bitonic sequence into a sorted one
 - definition: bitonic sequence

A sequence $S = \langle a_0, a_1, \dots, a_{N-1} \rangle$ is bitonic iff

- 1) there exists an index i , $0 \leq i \leq N-1$, such that $\langle a_0, \dots, a_i \rangle$ is monotonically increasing and $\langle a_{i+1}, \dots, a_{N-1} \rangle$ is monotonically decreasing, or
 - 2) there exists a cyclic shift of indices so that (1) is satisfied.
- example
 - $\langle 1, 2, 4, 7, 6, 0 \rangle$ first **increases** and then decreases
 - $\langle 8, 9, 2, 1, 0, 4 \rangle$ can be cyclic shifted to $\langle 0, 4, 8, 9, 2, 1 \rangle$

7 Examples of Parallel Algorithms

Sorting

- bitonic sort (cont'd)
 - let $S = \langle a_0, a_1, \dots, a_{N-1} \rangle$ be a bitonic sequence such that
 - $a_0 \leq a_1 \leq \dots \leq a_{N/2-1}$ and
 - $a_{N/2} \geq a_{N/2+1} \geq \dots \geq a_{N-1}$
 - consider the following subsequences of S
 - $S_1 = \langle \min\{a_0, a_{N/2}\}, \min\{a_1, a_{N/2+1}\}, \dots, \min\{a_{N/2-1}, a_{N-1}\} \rangle$
 - $S_2 = \langle \max\{a_0, a_{N/2}\}, \max\{a_1, a_{N/2+1}\}, \dots, \max\{a_{N/2-1}, a_{N-1}\} \rangle$
 - in sequence S_1 , there is an element $s_i = \min\{a_i, a_{N/2+i}\}$ such that all elements before s_i are from the increasing part of S and all elements after s_i are from the decreasing part of S
 - also, in sequence S_2 , there is an element $\hat{s}_i = \max\{a_i, a_{N/2+i}\}$ such that all elements before \hat{s}_i are from the decreasing part of S and all elements after \hat{s}_i are from the increasing part of S
 - hence, sequences S_1 and S_2 are bitonic sequences

7 Examples of Parallel Algorithms

Sorting

- bitonic sort (cont'd)
 - furthermore, $S_1 \leq S_2$ because s_i is greater than or equal to all elements of S_1 , \hat{s}_i is less than or equal to all elements of S_2 , and \hat{s}_i is greater than or equal s_i
 - hence, the initial problem of rearranging a bitonic sequence of size N was reduced to that of rearranging two smaller bitonic sequences of size $N/2$ and concatenating the results
 - this operation is further referred to as *bitonic split* (although assuming S_1 and S_2 had increasing / decreasing sequences of the same length, the bitonic split operation holds for any bitonic sequence)
 - the recursive usage of the bitonic split operation until all obtained subsequences are of size one leads to a sorted output in increasing order → sorting a bitonic sequence using bitonic splits is called *bitonic merge*

7 Examples of Parallel Algorithms

Sorting

- bitonic sort (cont'd)
 - example: bitonic merging network with 8 inputs (\oplus BM[8])

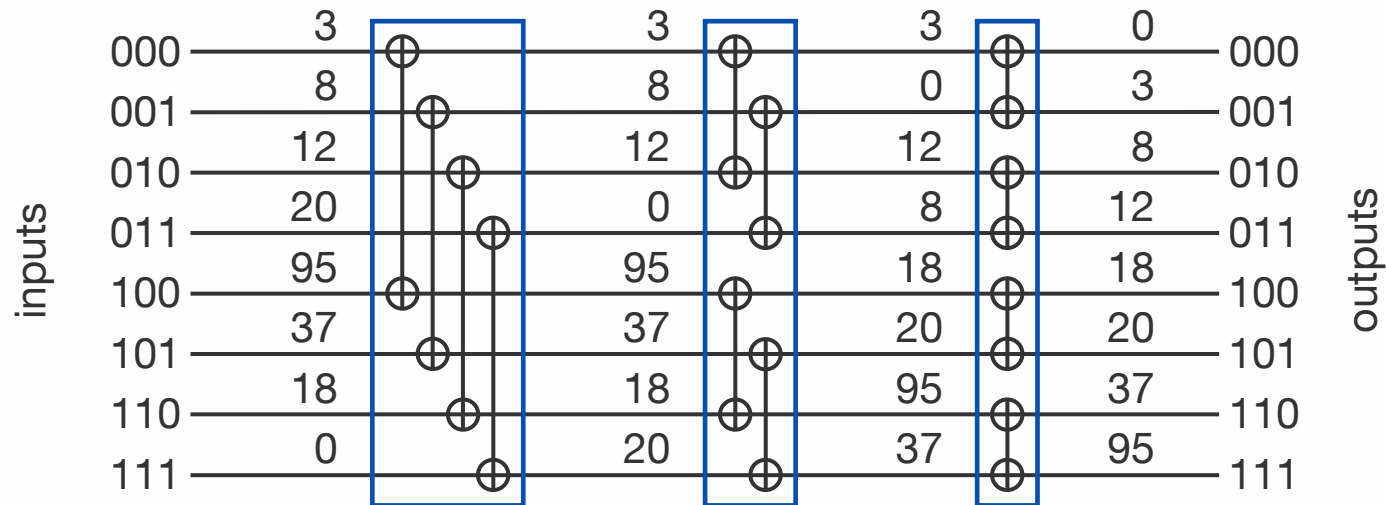

initial sequence	3	8	12	20	95	37	18	0
1st bitonic split	3	8	12	0	95	37	18	20
2nd bitonic split	3	0	12	8	18	20	95	37
3rd bitonic split	0	3	8	12	18	20	37	95

7 Examples of Parallel Algorithms

Sorting

- bitonic sort (cont'd)
 - for sorting bitonic sequence in decreasing order \oplus comparators have to be replaced by \ominus comparators $\rightarrow \ominus\text{BM}[8]$
 - problem: how to get a bitonic sequence $S = \langle a_0, a_1, \dots, a_{N-1} \rangle$ out of N unordered elements
 - construct S by repeatedly merging bitonic sequences of increasing length (here, the last bitonic merge ($\oplus\text{BM}[8]$) sorts the input)

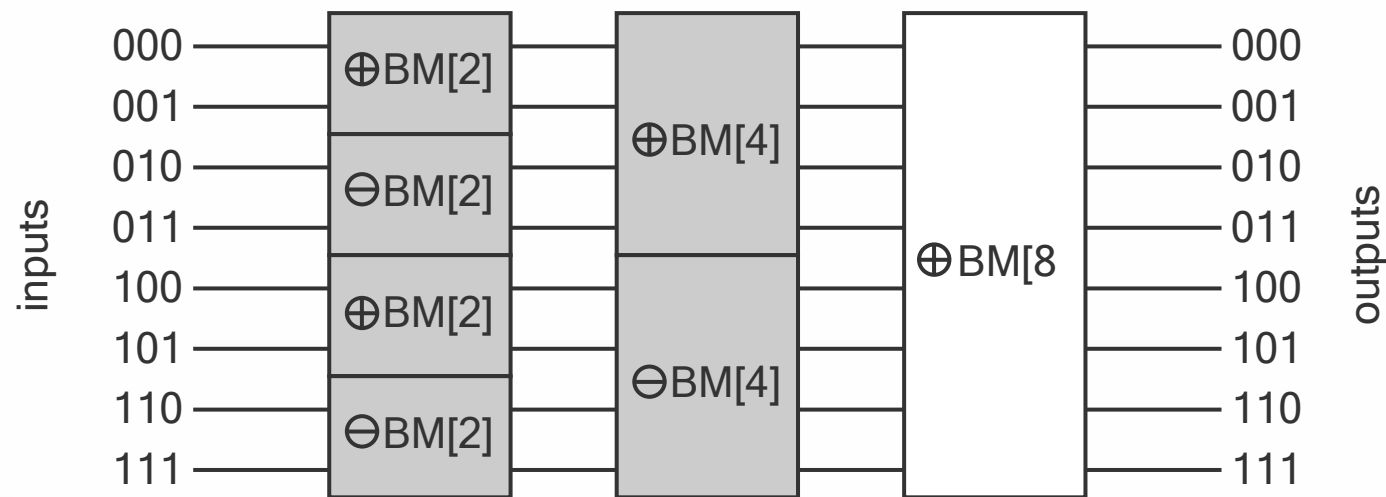

7 Examples of Parallel Algorithms

Sorting

- bitonic sort (cont'd)
 - example: bitonic sorting network with 8 inputs

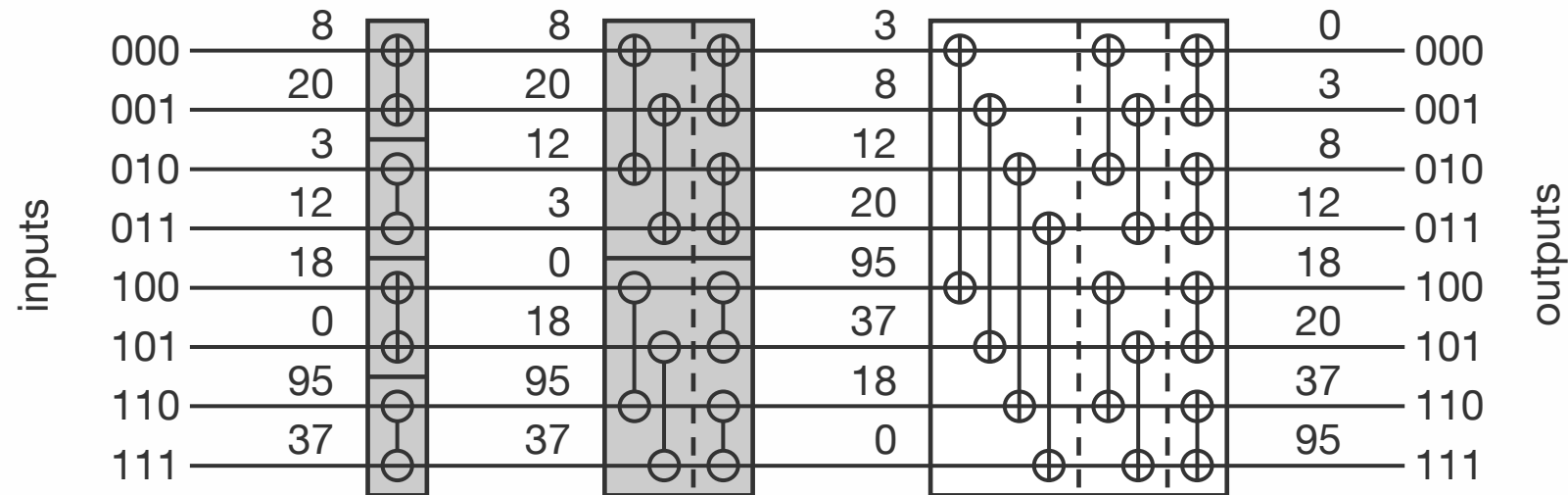

- depth $d(N)$ of a bitonic sorting network with N inputs can be computed by the following recursion

$$d(N) = d(N/2) + \log N$$

- hence, $d(N) = \sum_{i=1}^{\log N} i = (\log^2 N + \log N) / 2 = O(\log^2 N)$

7 Examples of Parallel Algorithms

Sorting

- bitonic sort (cont'd)
 - the bitonic algorithm is communication intensive → a proper mapping must take into account the underlying network topology
 - *hypercube*: compare-exchange operations take only place between nodes whose labels differ in one bit, i. e. within step D processes whose (binary) labels differ in the D^{th} bit compare-exchange their elements

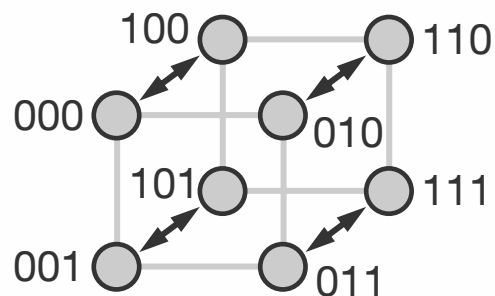

step 1

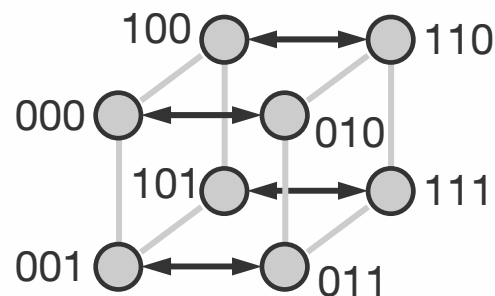

step 2

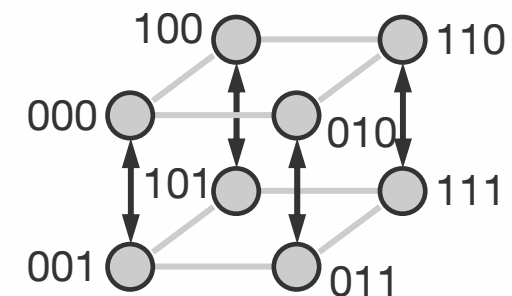

step 3

- *mesh*: there exist several possibilities for a proper mapping

7 Examples of Parallel Algorithms

Sorting

- again: merge sort
 - here, different approach for parallelisation of merge sort using a sorting network instead of a binary tree
 - idea
 - divide sequence A into blocks A_i of size N/P
 - parallel sort of blocks A_i via sequential merge sort with a complexity of $O((N/P) \cdot \log(N/P))$
 - parallel merge
 - 1) starting point: P sorted sublists each distributed over one processor
 - 2) merging two sublists using compare-split operations leads to $P/2$ sorted sublists each distributed over two processors
 - 3) repeatedly executing step 2 finally leads to one sorted list distributed over P processors

7 Examples of Parallel Algorithms

Sorting

- again: merge sort (cont'd)
 - example: repeated merge of sorted sublists for $P = 8$

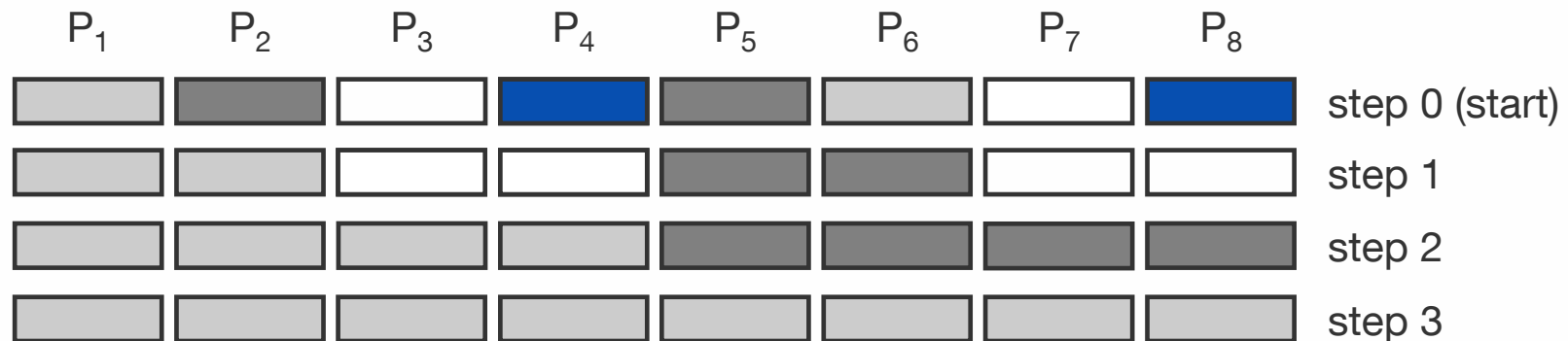

- there is a total of $\log P$ steps, where in the K^{th} step each processor performs K compare-split operations with its neighbours to obtain (parts of) a sorted list distributed over 2^K nodes
- hence, the parallel merge can be implemented by a sorting network with a complexity of $O(\log^2 P)$ compare-split operations

7 Examples of Parallel Algorithms

Sorting

- again: merge sort (cont'd)
 - example: parallel merge for $P = 8$ processors with $K = 3$ steps

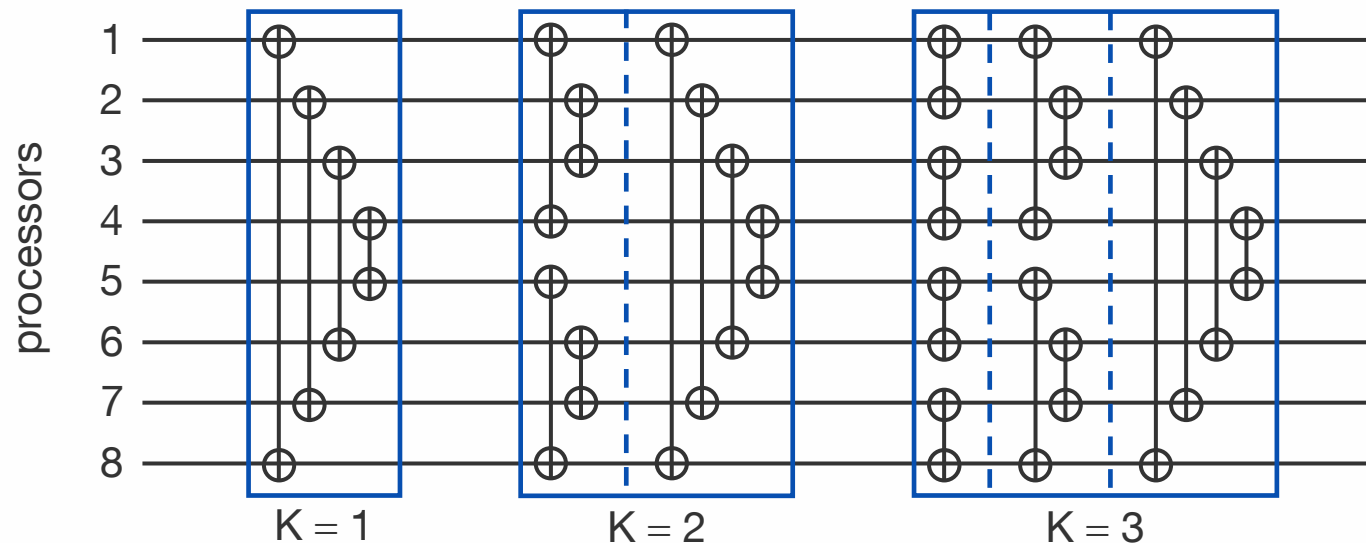

- total complexity of the parallel merge sort can be computed as

$$\underbrace{O((N/P) \cdot \log(N/P))}_{\text{local sort}} + \underbrace{O((N/P) \cdot \log^2 P)}_{\text{comparisons}} + \text{communication}$$